

TOSHIBA

FILE NO. SVM-16043

SERVICE MANUAL

AIR-CONDITIONER MULTI TYPE

INDOOR UNIT

< Concealed Duct Standard Type >

MMD-AP0076BHP1-E

MMD-AP0096BHP1-E

MMD-AP0126BHP1-E

MMD-AP0156BHP1-E

MMD-AP0186BHP1-E

MMD-AP0246BHP1-E

MMD-AP0276BHP1-E

MMD-AP0306BHP1-E

MMD-AP0366BHP1-E

MMD-AP0486BHP1-E

MMD-AP0566BHP1-E

MMD-AP0076BHP1-TR

MMD-AP0096BHP1-TR

MMD-AP0126BHP1-TR

MMD-AP0156BHP1-TR

MMD-AP0186BHP1-TR

MMD-AP0246BHP1-TR

MMD-AP0276BHP1-TR

MMD-AP0306BHP1-TR

MMD-AP0366BHP1-TR

MMD-AP0486BHP1-TR

MMD-AP0566BHP1-TR

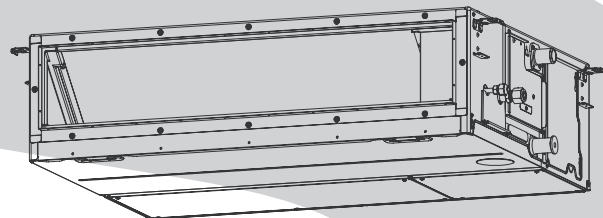

April 2016

CONTENTS

PRECAUTIONS FOR SAFETY	6
1. SPECIFICATIONS	13
2. AIR DUCTING WORK	15
3. CONSTRUCTION VIEWS (EXTERNAL VIEWS)	17
4. WIRING DIAGRAMS	19
5. PARTS RATING	20
6. REFRIGERANT CYCLE DIAGRAM	21
7. CONTROL OUTLINE	22
8. APPLIED CONTROL AND FUNCTIONS (INCLUDING CIRCUIT CONFIGURATION)	28
8-1. Indoor controller block diagram	28
8-1-1. In Case of Connection of Wired (Simple) Remote Controller	28
8-1-2. In Case of Connection of Wireless Remote Controller	29
8-1-3. Connection of Both Wired (Simple) Remote Controller and Wireless Remote Controller	30
8-2. Indoor Print Circuit Board MCC-1631	31
8-3. Optional connector specifications of indoor P.C. board	32
8-4. Test operation of indoor unit	33
8-5. Method to set indoor unit function DN code	34
8-6. Applied control of indoor unit	37
9. TROUBLESHOOTING	53
9-1. Overview	53
9-2. Troubleshooting method	54
9-3. Troubleshooting based on information displayed on remote controller	60
9-4. Check codes displayed on remote controller and SMMS outdoor unit (7-segment display on I/F board) and locations to be checked	65
9-5. Sensor characteristics	84
10. P.C. BOARD EXCHANGE PROCEDURES	85
10-1. Replacement of indoor P.C. boards	85
11. DETACHMENTS	91
12. EXPLODED VIEWS AND PARTS LIST	98

Original instruction

Please read carefully through these instructions that contain important information which complies with the “Machinery” Directive (Directive 2006/42/EC), and ensure that you understand them.

Generic Denomination: Air Conditioner

Definition of Qualified Installer or Qualified Service Person

The air conditioner must be installed, maintained, repaired and removed by a qualified installer or qualified service person. When any of these jobs is to be done, ask a qualified installer or qualified service person to do them for you.

A qualified installer or qualified service person is an agent who has the qualifications and knowledge described in the table below.

Agent	Qualifications and knowledge which the agent must have
Qualified installer	<ul style="list-style-type: none"> • The qualified installer is a person who installs, maintains, relocates and removes the air conditioners made by Toshiba Carrier Corporation. He or she has been trained to install, maintain, relocate and remove the air conditioners made by Toshiba Carrier Corporation or, alternatively, he or she has been instructed in such operations by an individual or individuals who have been trained and is thus thoroughly acquainted with the knowledge related to these operations. • The qualified installer who is allowed to do the electrical work involved in installation, relocation and removal has the qualifications pertaining to this electrical work as stipulated by the local laws and regulations, and he or she is a person who has been trained in matters relating to electrical work on the air conditioners made by Toshiba Carrier Corporation or, alternatively, he or she has been instructed in such matters by an individual or individuals who have been trained and is thus thoroughly acquainted with the knowledge related to this work. • The qualified installer who is allowed to do the refrigerant handling and piping work involved in installation, relocation and removal has the qualifications pertaining to this refrigerant handling and piping work as stipulated by the local laws and regulations, and he or she is a person who has been trained in matters relating to refrigerant handling and piping work on the air conditioners made by Toshiba Carrier Corporation or, alternatively, he or she has been instructed in such matters by an individual or individuals who have been trained and is thus thoroughly acquainted with the knowledge related to this work. • The qualified installer who is allowed to work at heights has been trained in matters relating to working at heights with the air conditioners made by Toshiba Carrier Corporation or, alternatively, he or she has been instructed in such matters by an individual or individuals who have been trained and is thus thoroughly acquainted with the knowledge related to this work.
Qualified service person	<ul style="list-style-type: none"> • The qualified service person is a person who installs, repairs, maintains, relocates and removes the air conditioners made by Toshiba Carrier Corporation. He or she has been trained to install, repair, maintain, relocate and remove the air conditioners made by Toshiba Carrier Corporation or, alternatively, he or she has been instructed in such operations by an individual or individuals who have been trained and is thus thoroughly acquainted with the knowledge related to these operations. • The qualified service person who is allowed to do the electrical work involved in installation, repair, relocation and removal has the qualifications pertaining to this electrical work as stipulated by the local laws and regulations, and he or she is a person who has been trained in matters relating to electrical work on the air conditioners made by Toshiba Carrier Corporation or, alternatively, he or she has been instructed in such matters by an individual or individuals who have been trained and is thus thoroughly acquainted with the knowledge related to this work. • The qualified service person who is allowed to do the refrigerant handling and piping work involved in installation, repair, relocation and removal has the qualifications pertaining to this refrigerant handling and piping work as stipulated by the local laws and regulations, and he or she is a person who has been trained in matters relating to refrigerant handling and piping work on the air conditioners made by Toshiba Carrier Corporation or, alternatively, he or she has been instructed in such matters by an individual or individuals who have been trained and is thus thoroughly acquainted with the knowledge related to this work. • The qualified service person who is allowed to work at heights has been trained in matters relating to working at heights with the air conditioners made by Toshiba Carrier Corporation or, alternatively, he or she has been instructed in such matters by an individual or individuals who have been trained and is thus thoroughly acquainted with the knowledge related to this work.

Definition of Protective Gear

When the air conditioner is to be transported, installed, maintained, repaired or removed, wear protective gloves and 'safety' work clothing.

In addition to such normal protective gear, wear the protective gear described below when undertaking the special work detailed in the table below.



Failure to wear the proper protective gear is dangerous because you will be more susceptible to injury, burns, electric shocks and other injuries.

Work undertaken	Protective gear worn
All types of work	Protective gloves 'Safety' working clothing
Electrical-related work	Gloves to provide protection for electricians and from heat Insulating shoes Clothing to provide protection from electric shock
Work done at heights (50 cm or more)	Helmets for use in industry
Transportation of heavy objects	Shoes with additional protective toe cap
Repair of outdoor unit	Gloves to provide protection for electricians and from heat

The important contents concerned to the safety are described on the product itself and on this Service Manual.



Please read this Service Manual after understanding the described items thoroughly in the following contents (Indications / Illustrated marks), and keep them.

[Explanation of indications]

Indication	Explanation
 DANGER	Indicates contents assumed that an imminent danger causing a death or serious injury of the repair engineers and the third parties when an incorrect work has been executed.
 WARNING	Indicates possibilities assumed that a danger causing a death or serious injury of the repair engineers, the third parties, and the users due to troubles of the product after work when an incorrect work has been executed.
 CAUTION	Indicates contents assumed that an injury or property damage (*) may be caused on the repair engineers, the third parties, and the users due to troubles of the product after work when an incorrect work has been executed.

* Property damage: Enlarged damage concerned to property, furniture, and domestic animal / pet

[Explanation of illustrated marks]







Indication	Explanation
	Indicates prohibited items (Forbidden items to do) The sentences near an illustrated mark describe the concrete prohibited contents.
	Indicates mandatory items (Compulsory items to do) The sentences near an illustrated mark describe the concrete mandatory contents.
	Indicates cautions (Including danger / warning) The sentences or illustration near or in an illustrated mark describe the concrete cautious contents.

Warning Indications on the Air Conditioner Unit

[Confirmation of warning label on the main unit]

Confirm that labels are indicated on the specified positions





If removing the label during parts replace, stick it as the original.

Warning indication		Description
	<p>WARNING</p> <p>ELECTRICAL SHOCK HAZARD Disconnect all remote electric power supplies before servicing.</p>	<p>WARNING</p> <p>ELECTRICAL SHOCK HAZARD Disconnect all remote electric power supplies before servicing.</p>
	<p>WARNING</p> <p>Moving parts. Do not operate unit with grille removed. Stop the unit before the servicing.</p>	<p>WARNING</p> <p>Moving parts. Do not operate unit with grille removed. Stop the unit before the servicing.</p>
	<p>CAUTION</p> <p>High temperature parts. You might get burned when removing this panel.</p>	<p>CAUTION</p> <p>High temperature parts. You might get burned when removing this panel.</p>
	<p>CAUTION</p> <p>Do not touch the aluminium fins of the unit. Doing so may result in injury.</p>	<p>CAUTION</p> <p>Do not touch the aluminium fins of the unit. Doing so may result in injury.</p>
	<p>CAUTION</p> <p>BURST HAZARD Open the service valves before the operation, otherwise there might be the burst.</p>	<p>CAUTION</p> <p>BURST HAZARD Open the service valves before the operation, otherwise there might be the burst.</p>
	<p>CAUTION</p> <p>Do not climb onto the fan guard. Doing so may result in injury.</p>	<p>CAUTION</p> <p>Do not climb onto the fan guard. Doing so may result in injury.</p>



PRECAUTIONS FOR SAFETY







The manufacturer shall not assume any liability for the damage caused by not observing the description of this manual.







DANGER



 Turn off braeaker	<p>Before carrying out the installation, maintenance, repair or removal work, be sure to set the circuit breaker for both the indoor and outdoor units to the OFF position. Otherwise, electric shocks may result.</p>
	<p>Before opening the electrical box cover of the indoor unit or service panel of the outdoor unit, set the circuit breaker to the OFF position. Failure to set the circuit breaker to the OFF position may result in electric shocks through contact with the interior parts. Only a qualified installer (*1) or qualified service person (*1) is allowed to remove the intake grille of the indoor unit or service panel of the outdoor unit and do the work required.</p>
	<p>Before opening the suction board cover, set the circuit breaker to the OFF position. Failure to set the circuit breaker to the OFF position may result in injury through contact with the rotation parts. Only a qualified installer (*1) or qualified service person (*1) is allowed to remove the suction board cover and do the work required.</p>
	<p>Before starting to repair the outdoor unit fan or fan guard, be absolutely sure to set the circuit breaker to the OFF position, and place a "Work in progress" sign on the circuit breaker.</p>
	<p>When cleaning the filter or other parts of the indoor unit, set the circuit breaker to OFF without fail, and place a "Work in progress" sign near the circuit breaker before proceeding with the work.</p>
 Electric shock hazard	<p>When you access inside of the service panel to repair electric parts, wait for about five minutes after turning off the breaker. Do not start repairing immediately. Otherwise you may get electric shock by touching terminals of high-voltage capacitors. Natural discharge of the capacitor takes about five minutes.</p>
	<p>When checking the electric parts, removing the cover of the electric parts box of Indoor Unit and/or service panel of Outdoor Unit inevitably to determine the failure, use gloves to provide protection for electricians, insulating shoes, clothing to provide protection from electric shock and insulating tools. Be careful not to touch the live part. Electric shock may result. Only "Qualified service person" is allowed to do this work.</p>
 Prohibition	<p>Place a "Work in progress" sign near the circuit breaker while the installation, maintenance, repair or removal work is being carried out. There is a danger of electric shocks if the circuit breaker is set to ON by mistake.</p>
	<p>When checking the electric parts, removing the cover of the electric parts box of Indoor Unit and/or front panel of Outdoor Unit inevitably to determine the failure, put a sign "Do not enter" around the site before the work. Failure to do this may result in third person getting electric shock.</p>
 Stay on protection	<p>Before operating the air conditioner after having completed the work, check that the electrical parts box cover of the indoor unit and service panel of the outdoor unit are closed, and set the circuit breaker to the ON position. You may receive an electric shock if the power is turned on without first conducting these checks.</p>
	<p>If, in the course of carrying out repairs, it becomes absolutely necessary to check out the electrical parts with the electrical parts box cover of one or more of the indoor units and the service panel of the outdoor unit removed in order to find out exactly where the trouble lies, wear insulated heat-resistant gloves, insulated boots and insulated work overalls, and take care to avoid touching any live parts. You may receive an electric shock if you fail to heed this warning. Only qualified service person (*1) is allowed to do this kind of work.</p>

 **WARNIG**

 General	<p>Before starting to repair the air conditioner, read carefully through the Service Manual, and repair the air conditioner by following its instructions.</p>
	<p>Only qualified service person (*1) is allowed to repair the air conditioner. Repair of the air conditioner by unqualified person may give rise to a fire, electric shocks, injury, water leaks and / or other problems.</p>
	<p>Do not use any refrigerant different from the one specified for complement or replacement. Otherwise, abnormally high pressure may be generated in the refrigeration cycle, which may result in a failure or explosion of the product or an injury to your body.</p>
	<p>Only a qualified installer (*1) or qualified service person (*1) is allowed to carry out the electrical work of the air conditioner. Under no circumstances must this work be done by an unqualified individual since failure to carry out the work properly may result in electric shocks and / or electrical leaks.</p>
	<p>When the air conditioner is to be transported, installed, maintained, repaired or removed, wear protective gloves and 'safety' work clothing.</p>
	<p>To connect the electrical wires, repair the electrical parts or undertake other electrical jobs, wear gloves to provide protection for electricians, insulating shoes and clothing to provide protection from electric shocks. Failure to wear this protective gear may result in electric shocks.</p>
	<p>Electrical wiring work shall be conducted according to law and regulation in the community and installation manual. Failure to do so may result in electrocution or short circuit.</p>
	<p>Use wiring that meets the specifications in the Installation Manual and the stipulations in the local regulations and laws. Use of wiring which does not meet the specifications may give rise to electric shocks, electrical leakage, smoking and/or a fire.</p>
	<p>Only a qualified installer (*1) or qualified service person (*1) is allowed to undertake work at heights using a stand of 50 cm or more or to remove the intake grille of the indoor unit to undertake work.</p>
	<p>When working at heights, use a ladder which complies with the ISO 14122 standard, and follow the procedure in the ladder's instructions. Also wear a helmet for use in industry as protective gear to undertake the work.</p>
	<p>Before working at heights, put a sign in place so that no-one will approach the work location, before proceeding with the work. Parts and other objects may fall from above, possibly injuring a person below. While carrying out the work, wear a helmet for protection from falling objects.</p>
	<p>When executing address setting, test run, or troubleshooting through the checking window on the electric parts box, put on insulated gloves to provide protection from electric shock. Otherwise you may receive an electric shock.</p>
	<p>When the first filter comes out without connected to the other one, insert it once more to connect the two filters together and pull out them as connected. Do not insert hands to take out the second filter. You may injure Yourself.</p>
	<p>Do not touch the aluminum fin of the outdoor unit. You may injure yourself if you do so. If the fin must be touched for some reason, first put on protective gloves and safety work clothing, and then proceed.</p>
	<p>Do not climb onto or place objects on top of the outdoor unit. You may fall or the objects may fall off of the outdoor unit and result in injury.</p>
	<p>Use forklift to carry in the air conditioner units and use winch or hoist at installation of them.</p>
	<p>When transporting the air conditioner, wear shoes with protective toe caps, protective gloves and other protective clothing.</p>
	<p>When transporting the air conditioner, do not take hold of the bands around the packing carton. You may injure yourself if the bands should break.</p>
<p>Be sure that a heavy unit (10 kg or heavier) such as a compressor is carried by two persons.</p>	
<p>This air conditioner has passed the pressure test as specified in IEC 60335-2-40 Annex EE.</p>	
 Check earth wires.	<p>Before troubleshooting or repair work, check the earth wire is connected to the earth terminals of the main unit, otherwise an electric shock is caused when a leak occurs. If the earth wire is not correctly connected, contact an electric engineer for rework.</p>
	<p>After completing the repair or relocation work, check that the ground wires are connected properly.</p>
	<p>Be sure to connect earth wire. (Grounding work) Incomplete grounding causes an electric shock. Do not connect ground wires to gas pipes, water pipes, and lightning rods or ground wires for telephone wires.</p>

 Prohibition of modification.	Do not modify the products. Do not also disassemble or modify the parts. It may cause a fire, electric shock or injury.
 Use specified parts.	When any of the electrical parts are to be replaced, ensure that the replacement parts satisfy the specifications given in the Service Manual (or use the parts contained on the parts list in the Service Manual). Use of any parts which do not satisfy the required specifications may give rise to electric shocks, smoking and / or a fire.
 Do not bring a child close to the equipment.	If, in the course of carrying out repairs, it becomes absolutely necessary to check out the electrical parts with the electrical parts box cover of one or more of the indoor units and the service panel of the outdoor unit removed in order to find out exactly where the trouble lies, put a sign in place so that no one will approach the work location before proceeding with the work. Third-party individuals may enter the work site and receive electric shocks if this warning is not heeded.
 Insulating measures	Connect the cut-off lead wires with crimp contact, etc., put the closed end side upward and then apply a watercut method, otherwise a leak or production of fire is caused at the users' side.
 No fire	When performing repairs using a gas burner, replace the refrigerant with nitrogen gas because the oil that coats the pipes may otherwise burn. When repairing the refrigerating cycle, take the following measures. 1) Be attentive to fire around the cycle. When using a gas stove, etc., be sure to put out fire before work; otherwise the oil mixed with refrigerant gas may catch fire. 2) Do not use a welder in the closed room. When using it without ventilation, carbon monoxide poisoning may be caused. 3) Do not bring inflammables close to the refrigerant cycle, otherwise fire of the welder may catch the inflammables.
 Refrigerant	The refrigerant used by this air conditioner is the R410A. Check the used refrigerant name and use tools and materials of the parts which match with it. For the products which use R410A refrigerant, the refrigerant name is indicated at a position on the outdoor unit where is easy to see. To prevent miss-charging, the route of the service port is changed from one of the former R22. Do not use any refrigerant different from the one specified for complement or replacement. Otherwise, abnormally high pressure may be generated in the refrigeration cycle, which may result in a failure or explosion of the product or an injury to your body. For an air conditioner which uses R410A, never use other refrigerant than R410A. For an air conditioner which uses other refrigerant (R22, etc.), never use R410A. If different types of refrigerant are mixed, abnormal high pressure generates in the refrigerating cycle and an injury due to breakage may be caused. When the air conditioner has been installed or relocated, follow the instructions in the Installation Manual and purge the air completely so that no gases other than the refrigerant will be mixed in the refrigerating cycle. Failure to purge the air completely may cause the air conditioner to malfunction. Do not charge refrigerant additionally. If charging refrigerant additionally when refrigerant gas leaks, the refrigerant composition in the refrigerating cycle changes resulted in change of air conditioner characteristics or refrigerant over the specified standard amount is charged and an abnormal high pressure is applied to the inside of the refrigerating cycle resulted in cause of breakage or injury. Therefore if the refrigerant gas leaks, recover the refrigerant in the air conditioner, execute vacuuming, and then newly recharge the specified amount of liquid refrigerant. In this time, never charge the refrigerant over the specified amount. When recharging the refrigerant in the refrigerating cycle, do not mix the refrigerant or air other than R410A into the specified refrigerant. If air or others is mixed with the refrigerant, abnormal high pressure generates in the refrigerating cycle resulted in cause of injury due to breakage. After installation work, check the refrigerant gas does not leak. If the refrigerant gas leaks in the room, poisonous gas generates when gas touches to fire such as fan heater, stove or cooking stove though the refrigerant gas itself is innocuous. Never recover the refrigerant into the outdoor unit. When the equipment is moved or repaired, be sure to recover the refrigerant with recovering device. The refrigerant cannot be recovered in the outdoor unit; otherwise a serious accident such as breakage or injury is caused.

 Assembly / Wiring	After repair work, surely assemble the disassembled parts, and connect and lead the removed wires as before. Perform the work so that the cabinet or panel does not catch the inner wires. If incorrect assembly or incorrect wire connection was done, a disaster such as a leak or fire is caused at user's side.
 Insulator check	After the work has finished, be sure to use an insulation tester set (500 V Megger) to check the resistance is 1 MΩ or more between the charge section and the non-charge metal section (Earth position). If the resistance value is low, a disaster such as a leak or electric shock is caused at user's side.
 Ventilation	When the refrigerant gas leaks during work, execute ventilation. If the refrigerant gas touches to a fire, poisonous gas generates. A case of leakage of the refrigerant and the closed room full with gas is dangerous because a shortage of oxygen occurs. Be sure to execute ventilation. If refrigerant gas has leaked during the installation work, ventilate the room immediately. If the leaked refrigerant gas comes in contact with fire, noxious gas may generate. After installation work, check the refrigerant gas does not leak. If the refrigerant gas leaks in the room, poisonous gas generates when gas touches to fire such as fan heater, stove or cooking stove though the refrigerant gas itself is innocuous.
 Compulsion	When the refrigerant gas leaks, find up the leaked position and repair it surely. If the leaked position cannot be found up and the repair work is interrupted, pump-down and tighten the service valve, otherwise the refrigerant gas may leak into the room. The poisonous gas generates when gas touches to fire such as fan heater, stove or cooking stove though the refrigerant gas itself is innocuous. When installing equipment which includes a large amount of charged refrigerant such as a multi air conditioner in a sub-room, it is necessary that the density does not the limit even if the refrigerant leaks. If the refrigerant leaks and exceeds the limit density, an accident of shortage of oxygen is caused. Tighten the flare nut with a torque wrench in the specified manner. Excessive tighten of the flare nut may cause a crack in the flare nut after a long period, which may result in refrigerant leakage. Nitrogen gas must be used for the airtight test. The charge hose must be connected in such a way that it is not slack. For the installation / moving / reinstallation work, follow to the Installation Manual. If an incorrect installation is done, a trouble of the refrigerating cycle, water leak, electric shock or fire is caused.
 Check after repair	Once the repair work has been completed, check for refrigerant leaks, and check the insulation resistance and water drainage. Then perform a trial run to check that the air conditioner is running properly. After repair work has finished, check there is no trouble. If check is not executed, a fire, electric shock or injury may be caused. For a check, turn off the power breaker. After repair work (installation of front panel and cabinet) has finished, execute a test run to check there is no generation of smoke or abnormal sound. If check is not executed, a fire or an electric shock is caused. Before test run, install the front panel and cabinet. Be sure to fix the screws back which have been removed for installation or other purposes.
 Do not operate the unit with the valve closed.	Check the following matters before a test run after repairing piping. <ul style="list-style-type: none"> • Connect the pipes surely and there is no leak of refrigerant. • The valve is opened. Running the compressor under condition that the valve closes causes an abnormal high pressure resulted in damage of the parts of the compressor and etc. and moreover if there is leak of refrigerant at connecting section of pipes, the air is sucked and causes further abnormal high pressure resulted in burst or injury.
 Check after reinstallation	Only a qualified installer (*1) or qualified service person (*1) is allowed to relocate the air conditioner. It is dangerous for the air conditioner to be relocated by an unqualified individual since a fire, electric shocks, injury, water leakage, noise and / or vibration may result. Check the following items after reinstallation. <ol style="list-style-type: none"> 1) The earth wire is correctly connected. 2) The power cord is not caught in the product. 3) There is no inclination or unsteadiness and the installation is stable. If check is not executed, a fire, an electric shock or an injury is caused. When carrying out the pump-down work shut down the compressor before disconnecting the refrigerant pipe. Disconnecting the refrigerant pipe with the service valve left open and the compressor still operating will cause air, etc. to be sucked in, raising the pressure inside the refrigeration cycle to an abnormally high level, and possibly resulting in reputeing, injury, etc.

 Cooling check	<p>When the service panel of the outdoor unit is to be opened in order for the compressor or the area around this part to be repaired immediately after the air conditioner has been shut down, set the circuit breaker to the OFF position, and then wait at least 10 minutes before opening the service panel. If you fail to heed this warning, you will run the risk of burning yourself because the compressor pipes and other parts will be very hot to the touch. In addition, before proceeding with the repair work, wear the kind of insulated heat-resistant gloves designed to protect electricians.</p>
	<p>Take care not to get burned by compressor pipes or other parts when checking the cooling cycle while running the unit as they get heated while running. Be sure to put on gloves providing protection for heat.</p>
 Installation	<p>When the service panel of the outdoor unit is to be opened in order for the fan motor, reactor, inverter or the areas around these parts to be repaired immediately after the air conditioner has been shut down, set the circuit breaker to the OFF position, and then wait at least 10 minutes before opening the service panel. If you fail to heed this warning, you will run the risk of burning yourself because the fan motor, reactor, inverter heat sink and other parts will be very hot to the touch. In addition, before proceeding with the repair work, wear the kind of insulated heat-resistant gloves designed to protect electricians.</p>
	<p>Only a qualified installer or service person is allowed to do installation work. Inappropriate installation may result in water leakage, electric shock or fire.</p>
	<p>Before starting to install the air conditioner, read carefully through the Installation Manual, and follow its instructions to install the air conditioner.</p>
	<p>Be sure to use the company-specified products for the separately purchased parts. Use of non-specified products may result in fire, electric shock, water leakage or other failure. Have the installation performed by a qualified installer.</p>
	<p>Do not supply power from the power terminal block equipped on the outdoor unit to another outdoor unit. Capacity overflow may occur on the terminal block and may result in fire.</p>
	<p>Do not install the air conditioner in a location that may be subject to a risk of exposure to a combustible gas. If a combustible gas leaks and becomes concentrated around the unit, a fire may occur.</p>
	<p>Install the indoor unit at least 2.5 m above the floor level since otherwise the users may injure themselves or receive electric shocks if they poke their fingers or other objects into the indoor unit while the air conditioner is running.</p>
	<p>Install a circuit breaker that meets the specifications in the installation manual and the stipulations in the local regulations and laws.</p>
	<p>Install the circuit breaker where it can be easily accessed by the qualified service person (*1).</p>
	<p>If you install the unit in a small room, take appropriate measures to prevent the refrigerant from exceeding the limit concentration even if it leaks. Consult the dealer from whom you purchased the air conditioner when you implement the measures. Accumulation of highly concentrated refrigerant may cause an oxygen deficiency accident.</p>
	<p>Do not place any combustion appliance in a place where it is directly exposed to the wind of air conditioner, otherwise it may cause imperfect combustion.</p>
<p>When mounting the rails, push them until the 3 latches click. (Concealed duct type only)</p>	
<p>Insert the filters into the direction which the arrows, carved on the filters, show. (2 filters are identical)</p>	

Explanations given to user

If you have discovered that the fan grille is damaged, do not approach the outdoor unit but set the circuit breaker to the OFF position, and contact a qualified service person to have the repairs done. Do not set the circuit breaker to the ON position until the repairs are completed.

Relocation

- Only a qualified installer (*1) or qualified service person (*1) is allowed to relocate the air conditioner. It is dangerous for the air conditioner to be relocated by an unqualified individual since a fire, electric shocks, injury, water leakage, noise and / or vibration may result.
- When carrying out the pump-down work shut down the compressor before disconnecting the refrigerant pipe. Disconnecting the refrigerant pipe with the service valve left open and the compressor still operating will cause air, etc. to be sucked in, raising the pressure inside the refrigeration cycle to an abnormally high level, and possibly resulting in rupturing, injury, etc.

(*1) Refer to the “Definition of Qualified Installer or Qualified Service Person”

Declaration of Conformity

Manufacturer: TOSHIBA CARRIER (THAILAND) CO., LTD.
144 / 9 Moo 5, Bangkadi Industrial Park, Tivanon Road,
Tambon Bangkadi, Amphur Muang, Pathumthani 12000, Thailand

Authorized Representative / Nick Ball

TCF holder: Toshiba EMEA Engineering Director
Toshiba Carrier UK Ltd.
Porsham Close, Belliver Industrial Estate,
PLYMOUTH, Devon, PL6 7DB.
United Kingdom

Hereby declares that the machinery described below:

Generic Denomination: Air Conditioner

Model / type: Indoor unit
<Concealed Duct Standard Type>
MMD-AP0076BHP1-E(TR) MMD-AP0096BHP1-E(TR),
MMD-AP0126BHP1-E(TR) MMD-AP0156BHP1-E(TR),
MMD-AP0186BHP1-E(TR) MMD-AP0246BHP1-E(TR),
MMD-AP0276BHP1-E(TR) MMD-AP0306BHP1-E(TR),
MMD-AP0366BHP1-E(TR) MMD-AP0486BHP1-E(TR),
MMD-AP0566BHP1-E(TR)

Commercial name: Super Modular Multi System Air Conditioner
Super Heat Recovery Multi System Air Conditioner
MiNi-Super Modular Multi System Air Conditioner (MiNi-SMMS series)

Complies with the provisions of the "Machinery" Directive (Directive 2006/42/EC) and the regulations transposing into national law

"Declaration of incorporation of partly completed machinery"

Must not be put into service until the final machinery into which it is to be incorporated has been declared in conformity with the provisions of this Directive, where appropriate.

Complies with the provisions of the following harmonized standard:
EN 378-2: 2008+A2:2012

NOTE

This declaration becomes invalid if technical or operational modifications are introduced without the manufacturer's consent.

Specifications

Model	Sound Pressure level (dBA)		Weight (kg) Main unit
	Cooling	Heating	
MMD-AP0076BHP1-E	*	*	23
MMD-AP0096BHP1-E	*	*	23
MMD-AP0126BHP1-E	*	*	23
MMD-AP0156BHP1-E	*	*	23
MMD-AP0186BHP1-E	*	*	23
MMD-AP0246BHP1-E	*	*	30
MMD-AP0276BHP1-E	*	*	30
MMD-AP0306BHP1-E	*	*	30
MMD-AP0366BHP1-E	*	*	40
MMD-AP0486BHP1-E	*	*	40
MMD-AP0566BHP1-E	*	*	40
MMD-AP0076BHP1-TR	*	*	23
MMD-AP0096BHP1-TR	*	*	23
MMD-AP0126BHP1-TR	*	*	23
MMD-AP0156BHP1-TR	*	*	23
MMD-AP0186BHP1-TR	*	*	23
MMD-AP0246BHP1-TR	*	*	30
MMD-AP0276BHP1-TR	*	*	30
MMD-AP0306BHP1-TR	*	*	30
MMD-AP0366BHP1-TR	*	*	40
MMD-AP0486BHP1-TR	*	*	40
MMD-AP0566BHP1-TR	*	*	40

*: Under 70 dBA

1. SPECIFICATIONS

(50Hz)

Model name		MMD-AP****BHP1-E(TR)										
		0076	0096	0126	0156	0186	0246	0276	0306	0366	0486	0566
Cooling/Heating capacity (Note 1) (kW)		2.2/2.5	2.8/3.2	3.6/4.0	4.5/5.0	5.6/6.3	7.1/8.0	8.0/9.0	9.0/10.0	11.2/12.5	14.0/16.0	16.0/18.0
Electrical characteristics	Power supply	1phase 50Hz 230V(220V-240V)										
	Running current (A)	0.26	0.29	0.42	0.52	0.61	1.07	1.23				
	Power consumption (kW)	0.038	0.043	0.062	0.077	0.094	0.172	0.198				
	Starting current (A)	0.45	0.50	0.73	0.90	1.06	1.85	2.13				
Appearance		Zinc hot dipping steel plate										
Dimension	Height (mm)	275										
	Width (mm)	700				1000			1400			
	Depth (mm)	750										
Total weight (kg)		23				30			40			
Heat exchanger		Finned tube										
Soundproof / Heat-insulating material		Polyethylene foam										
Fan unit	Fan	Centrifugal fan										
	Standard air flow (m ³ /h) (Med./Low)	540 (450/360)	570 (480/390)	800 (660/540)	1,200 (990/870)	1,260 (1110/930)	1,920 (1620/1380)	2,100 (1740/1500)				
	Motor output (W)	150						250				
	External static pressure (Pa) (factory setting)	30				40			50			
	External static pressure (Pa)	30-40-50-65-80-100-120 (7steps)										
Controller		Remote controller										
Air filter		Standard filter (Long life filter)										
Connecting pipe	Gas side (mm)	9.5			12.7			15.9				
	Liquid side (mm)	6.4						9.5				
	Drain port (mm)	25(Polyvinyl chloride tube)										
Sound pressure level (Note 2) (High/Med./Low)		29/26/23	30/26/23	33/29/25	36/31/27	40/36/33						

Note 1 : The cooling capacities and electrical characteristics are measured under the conditions specified by JIS B 8615 based on the reference piping.

The reference piping consists of 5 m of main piping and 2.5 m of branch piping connected with 0 m height.

Note 2 : The sound level are measured in an anechoic chamber in accordance with JIS B 8616.

Normally, the values measured in the actual operating environment become larger than the indicated values due to the effects of external sound.

Note : Rated conditions Cooling: Indoor air temperature 27°C DB/19°C WB, Outdoor air temperature 35°C DB
Heating: Indoor air temperature 20°C DB, Outdoor air temperature 7°C DB/6°C WB

(60Hz)

Model name		MMD-AP****BHP1-E(TR)										
		0076	0096	0126	0156	0186	0246	0276	0306	0366	0486	0566
Cooling/Heating capacity (Note 1) (kW)		2.2/2.5	2.8/3.2	3.6/4.0	4.5/5.0	5.6/6.3	7.1/8.0	8.0/9.0	9.0/10.0	11.2/12.5	14.0/16.0	16.0/18.0
Electrical characteristics	Power supply	1phase 60Hz 220V										
	Running current (A)	0.27	0.31	0.44	0.55	0.64	1.12	1.29				
	Power consumption (kW)	0.038	0.043	0.062	0.077	0.094	0.172	0.198				
	Starting current (A)	0.47	0.54	0.76	0.95	1.11	1.94	2.23				
Appearance		Zinc hot dipping steel plate										
Dimension	Height (mm)	275										
	Width (mm)	700				1000			1400			
	Depth (mm)	750										
Total weight (kg)		23				30			40			
Heat exchanger		Finned tube										
Soundproof / Heat-insulating material		Polyethylene foam										
Fan unit	Fan	Centrifugal fan										
	Standard air flow (m ³ /h) (Med./Low)	540 (450/360)	570 (480/390)	800 (660/540)	1,200 (990/870)	1,260 (1110/930)	1,920 (1620/1380)	2,100 (1740/1500)				
	Motor output (W)	150						250				
	External static pressure (Pa) (factory setting)	30				40			50			
	External static pressure (Pa)	30-40-50-65-80-100-120 (7steps)										
Controller		Remote controller										
Air filter		Standard filter (Long life filter)										
Connecting pipe	Gas side (mm)	9.5			12.7		15.9					
	Liquid side (mm)	6.4					9.5					
	Drain port (mm)	25(Polyvinyl chloride tube)										
Sound pressure level (Note 2) (High/Med./Low)		29/26/23	30/26/23	33/29/25	36/31/27	40/36/33						

Note 1 : The cooling capacities and electrical characteristics are measured under the conditions specified by JIS B 8615 based on the reference piping.

The reference piping consists of 5 m of main piping and 2.5 m of branch piping connected with 0 m height.

Note 2 : The sound level are measured in an anechoic chamber in accordance with JIS B 8616.

Normally, the values measured in the actual operating environment become larger than the indicated values due to the effects of external sound.

Note : Rated conditions Cooling: Indoor air temperature 27°C DB/19°C WB, Outdoor air temperature 35°C DB
Heating: Indoor air temperature 20°C DB, Outdoor air temperature 7°C DB/6°C WB

2. AIR DUCTING WORK

AP0076 type

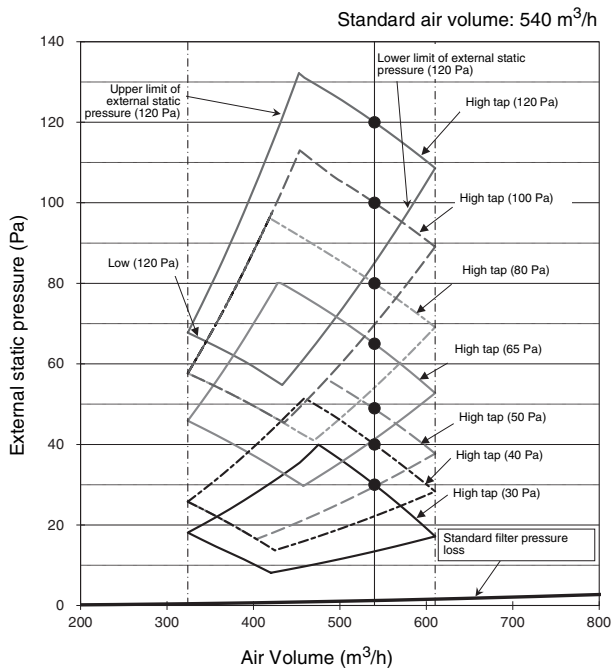

AP0096, AP0126 type

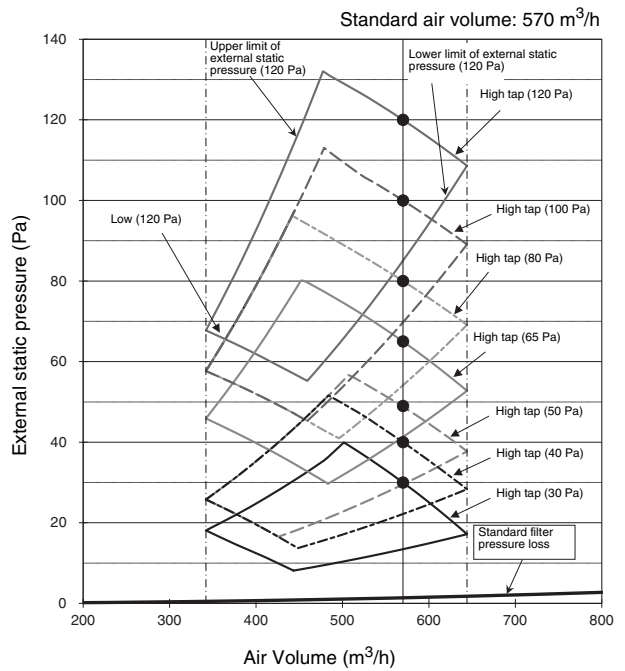

AP0156, AP0186 type

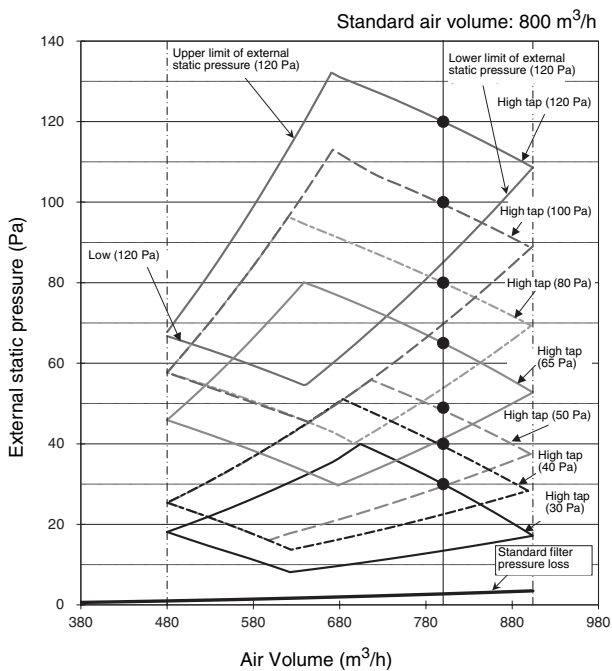

AP0246, AP0276 type

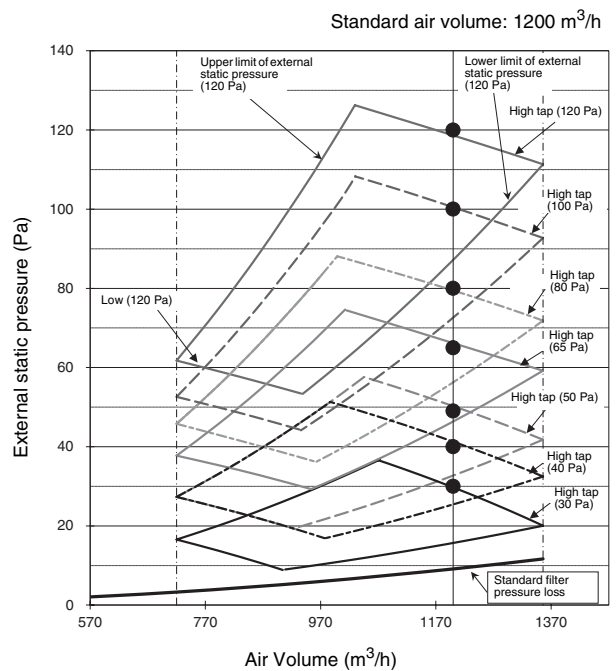

AP0306 type

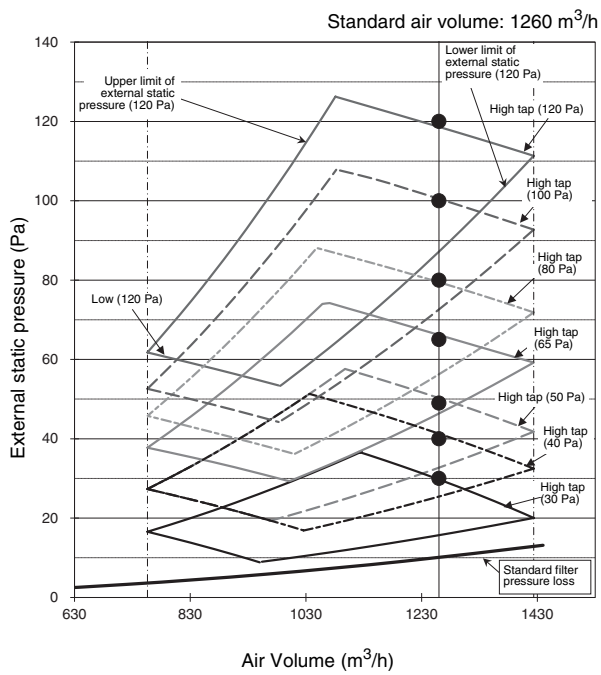

AP0366 type

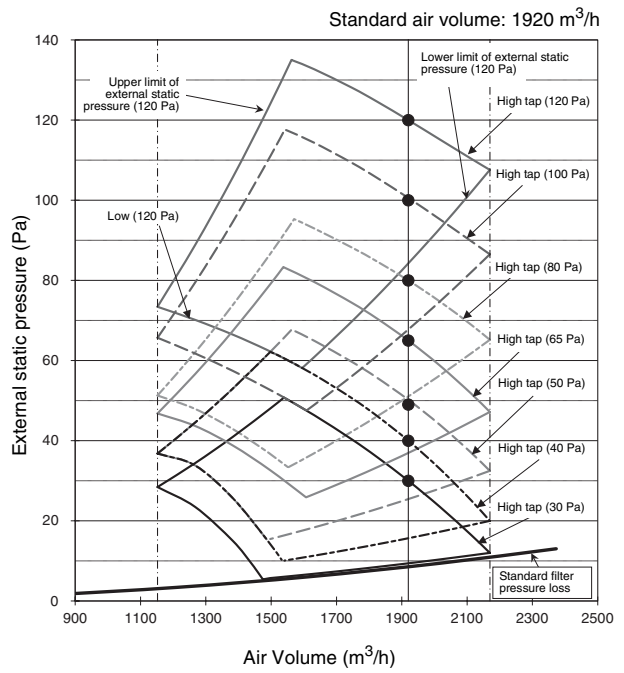

AP0486, AP0566 type

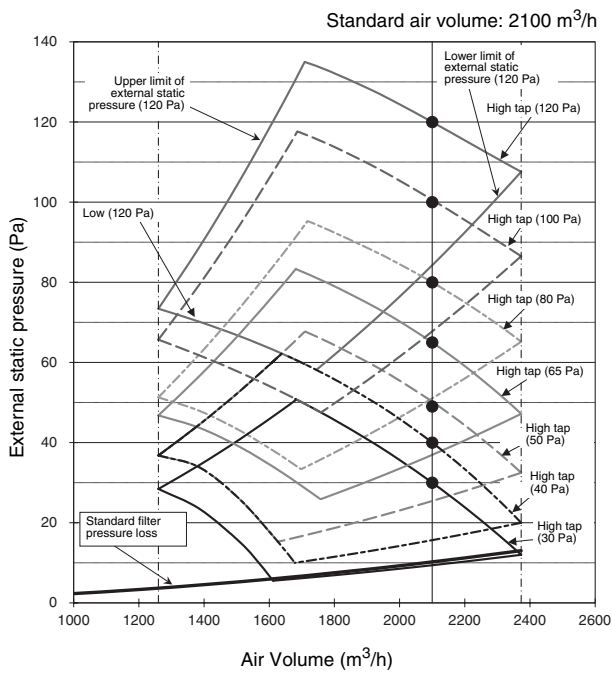

3. CONSTRUCTION VIEWS (EXTERNAL VIEWS)

MMD-AP0076BHP1*, AP0096BHP1*, AP0126BHP1*, AP0156BHP1*, AP0186BHP1*
 AP0246BHP1*, AP0276BHP1*, AP0306BHP1*, AP0366BHP1*, AP0486BHP1*, AP0566BHP1*

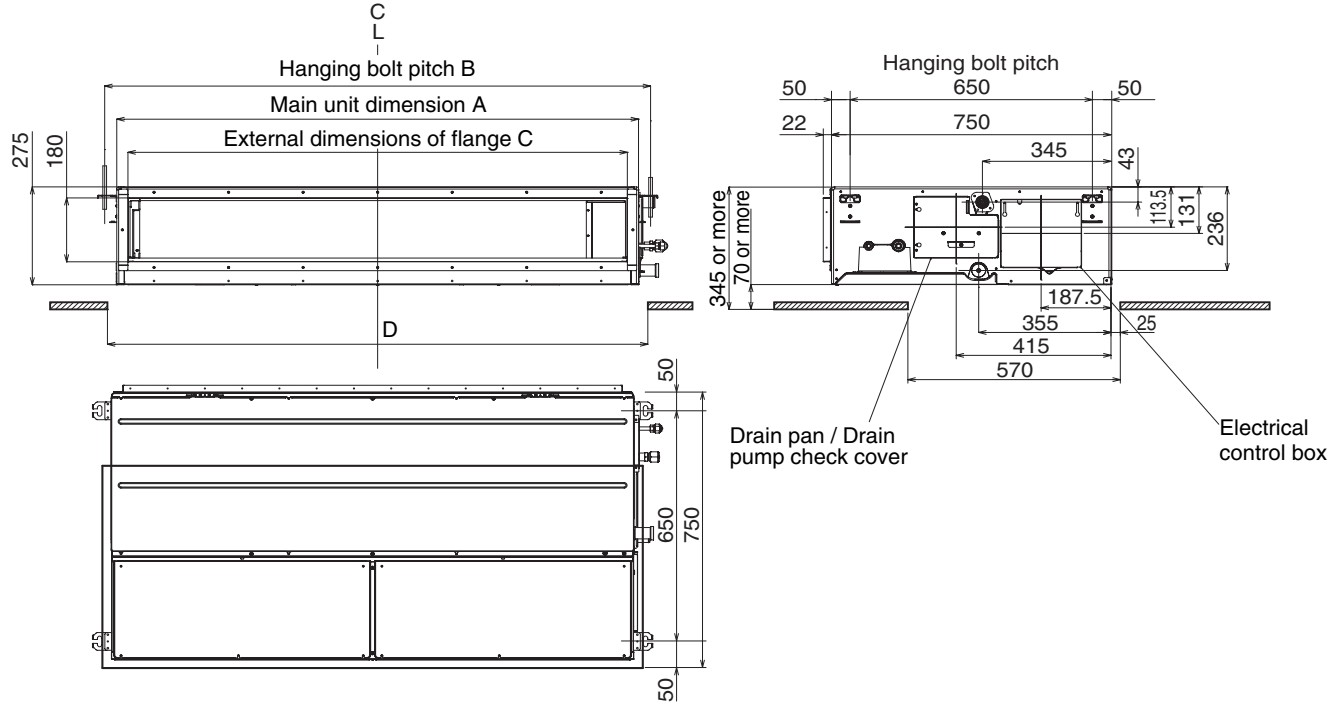

Dimension

	A	B	C	D	E
AP007 ~ 018 type	700	765	640	750	700
AP024 ~ 030 type	1000	1065	940	1050	500
AP036 ~ 056 type	1400	1465	1340	1450	700

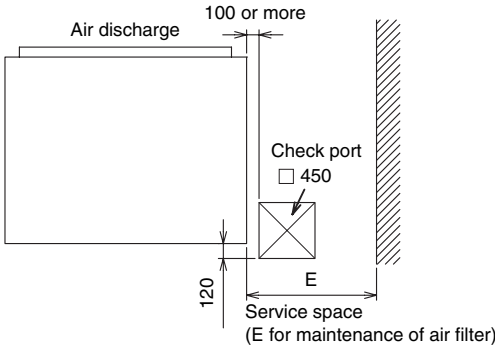

AP007 ~ AP018 type

<Under air intake>

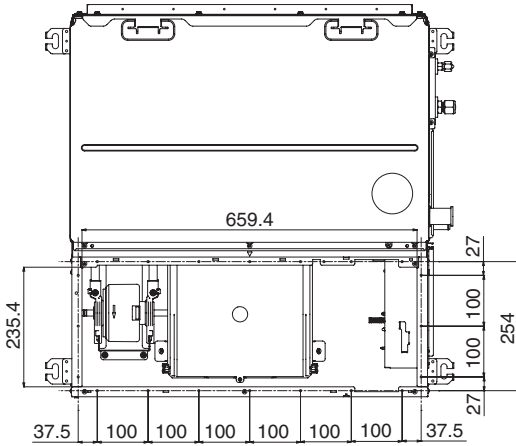

AP024 ~ AP030 type

<Under air intake>

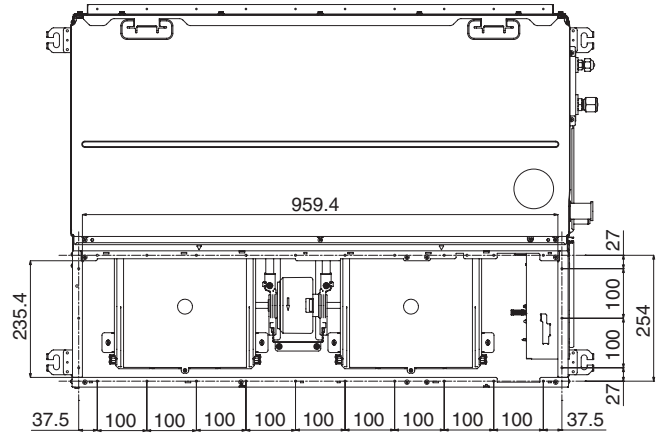

<Back air intake>

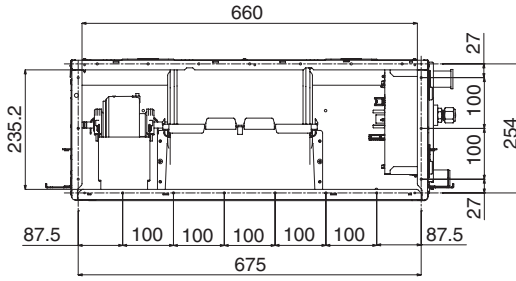

<Back air intake>

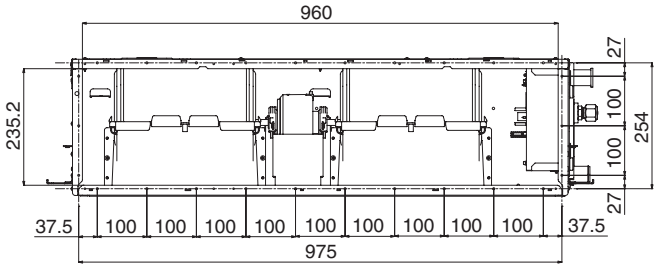

AP036 ~ AP056 type

<Under air intake>

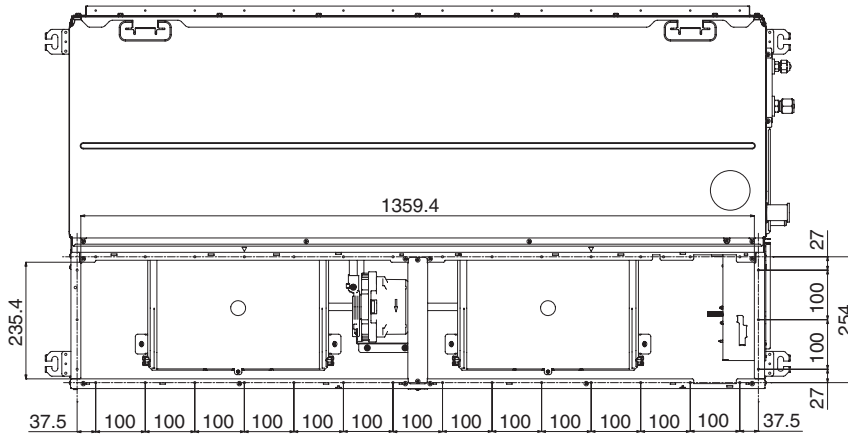

<Back air intake>

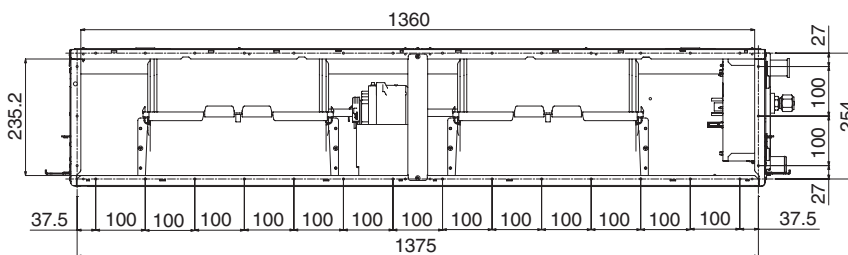

4. WIRING DIAGRAMS

Models : MMD-AP0076BHP1*, AP0096BHP1*, AP0126BHP1*, AP0156BHP1*, AP0186BHP1*, AP0246BHP1*, AP0276BHP1*, AP0306BHP1*, AP0366BHP1*, AP0486BHP1*, AP0566BHP1*

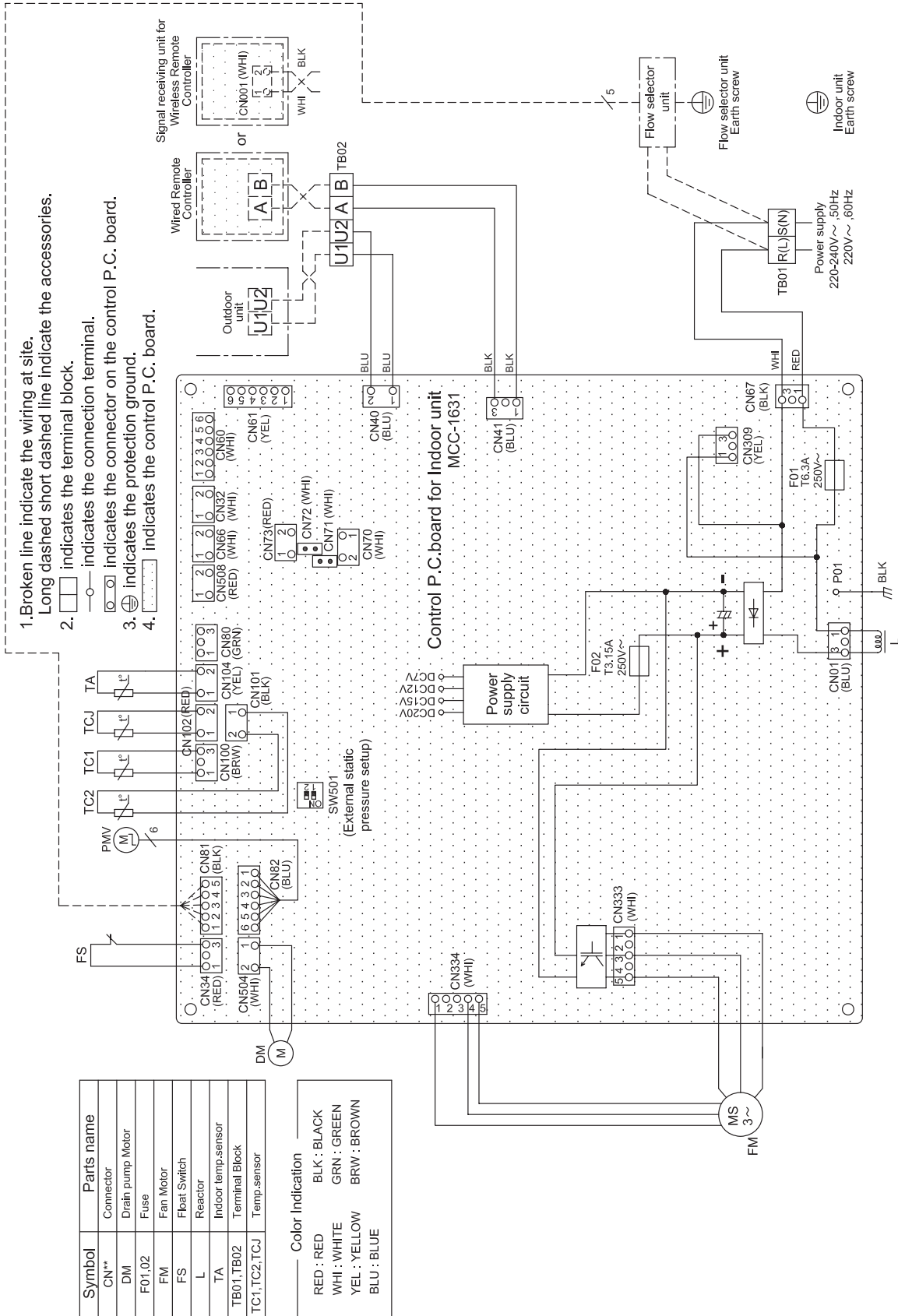

5. PARTS RATING

Model	MMD-AP	0076BHP1	0096BHP1	0126BHP1	0156BHP1	0186BHP1
Fan motor		ICF-340W150-2				
Drain pump motor		MDP-1401				
Float switch		FS-1A-31-3				
Pulse motor		EFM-MD12TF-1				
Pulse motor valve		EFM-25YGCTH-2			EFM-40YGTF-1	
TA sensor		Lead wire length: 218 mm				
TC1 sensor		Ø4 size lead wire length: 1000 mm Vinyl tube (Blue)				
TC2 sensor		Ø6 size lead wire length: 1000 mm Vinyl tube (Black)				
TCJ sensor		Ø6 size lead wire length: 1000 mm Vinyl tube (Red)				

Model	MMD-AP	0246BHP1	0276BHP1	0306BHP1	0366BHP1	0486BHP1	0566BHP1
Fan motor		340W150-1			340W250-1		
Drain pump motor		MDP-1401					
Float switch		FS-1A-31-3					
Pulse motor		EFM-MD12TF-1					
Pulse motor valve		EFM-40YGTF-1			EFM-60YGCTH-1		
TA sensor		Lead wire length: 218 mm					
TC1 sensor		Ø4 size lead wire length: 1000 mm Vinyl tube (Blue)					
TC2 sensor		Ø6 size lead wire length: 1000 mm Vinyl tube (Black)					
TCJ sensor		Ø6 size lead wire length: 1000 mm Vinyl tube (Red)					

6. REFRIGERANT CYCLE DIAGRAM

Indoor unit

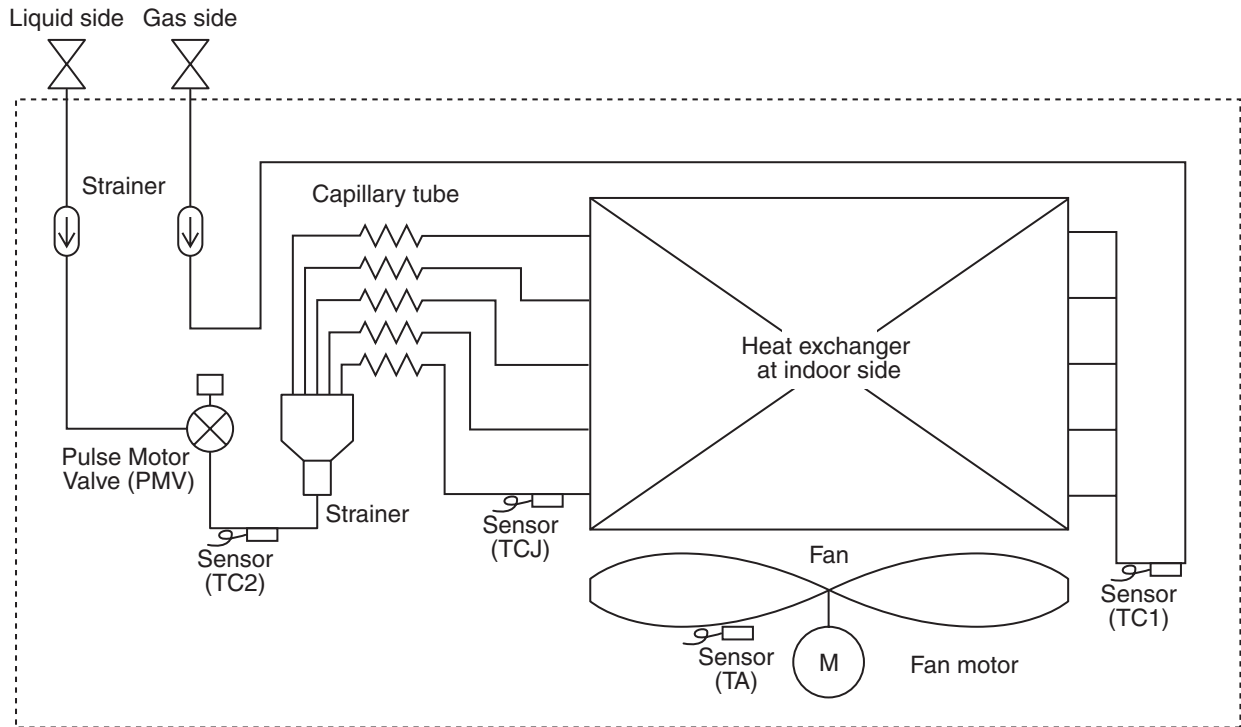

Explanation of functional parts in indoor unit



Functional part name		Functional outline
Pulse Motor Valve	PMV	(Connector CN082 (6P): Blue) 1) Controls super heat in cooling operation 2) Controls under cool in heating operation 3) Recovers refrigerant oil in cooling operation 4) Recovers refrigerant oil in heating operation
Temp. Sensor	1.TA	(Connector CN104 (2P): Yellow) 1) Detects indoor suction temperature
	2.TC1	(Connector CN100 (3P): Brown) 1) Controls PMV super heat in cooling operation
	3.TC2	(Connector CN101 (2P): Black) 1) Controls PMV under cool in heating operation
	4.TCJ	(Connector CN102 (2P): Red) 1) Controls PMV super heat in cooling operation

7. CONTROL OUTLINE

■ Indoor unit



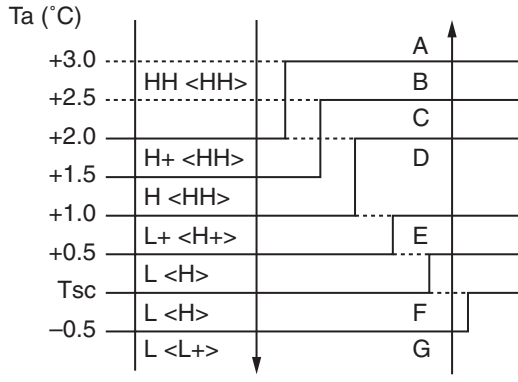
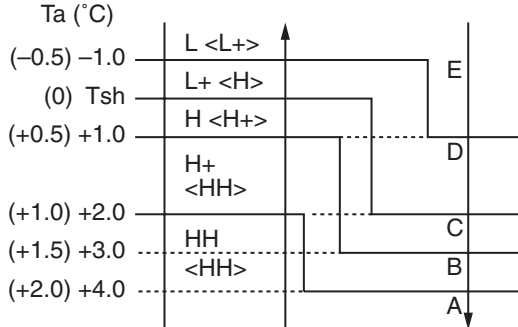



Control specifications



NO.	Item	Specification outline	Remarks																									
1	Upon power supply reset	<ol style="list-style-type: none"> 1. Identification of outdoor unit When the power supply is reset, the outdoor unit is identified, and control is redirected according to the identification result. 2. Indoor fan speed and air flow direction control availability settings Settings such as indoor fan speed and air flow direction control availability are replaced on the basis of EEPROM data. 3. If power supply reset is performed in the wake of a fault, the check code is cleared. If the abnormality persists after the Start / Stop button on the remote controller is pressed to resume operation, the check code is redisplayed on the remote controller. 																										
2	Operation selection	<ol style="list-style-type: none"> 1. The operation mode changes in response to an operation selection command issued via the remote controller. <table border="1" style="margin-left: 40px;"> <thead> <tr> <th>Remote controller command</th> <th>Control outline</th> </tr> </thead> <tbody> <tr> <td>STOP</td> <td>Air conditioner shutdown</td> </tr> <tr> <td>FAN</td> <td>Fan operation</td> </tr> <tr> <td>COOL</td> <td>Cooling operation</td> </tr> <tr> <td>DRY</td> <td>Drying operation</td> </tr> <tr> <td>HEAT</td> <td>Heating operation</td> </tr> </tbody> </table>	Remote controller command	Control outline	STOP	Air conditioner shutdown	FAN	Fan operation	COOL	Cooling operation	DRY	Drying operation	HEAT	Heating operation	Ts: Temperature setting Ta: Room temperature													
Remote controller command	Control outline																											
STOP	Air conditioner shutdown																											
FAN	Fan operation																											
COOL	Cooling operation																											
DRY	Drying operation																											
HEAT	Heating operation																											
3	Room temp. control	<ol style="list-style-type: none"> 1. Adjustment range - remote controller temperature setting (°C) <table border="1" style="margin-left: 40px;"> <thead> <tr> <th></th> <th>COOL / DRY</th> <th>HEAT</th> </tr> </thead> <tbody> <tr> <td>Wired type</td> <td>18~29</td> <td>18~29</td> </tr> <tr> <td>Wireless type</td> <td>18~30</td> <td>16~30</td> </tr> </tbody> </table> 2. In heating operation, the temperature setting may be fine-tuned via the DN code "06". <table border="1" style="margin-left: 40px;"> <thead> <tr> <th>SET DATA</th> <th>0</th> <th>2</th> <th>4</th> <th>6</th> </tr> </thead> <tbody> <tr> <td>Temperature setting adjustment</td> <td>+0 °C</td> <td>+2 °C</td> <td>+4 °C</td> <td>+6 °C</td> </tr> </tbody> </table> <p>Factory default</p> <table border="1" style="margin-left: 40px;"> <thead> <tr> <th>Model type</th> <th>SET DATA</th> </tr> </thead> <tbody> <tr> <td>Floor standing (standard, concealed, cabinet)</td> <td>0</td> </tr> <tr> <td>Other model</td> <td>2</td> </tr> </tbody> </table> 		COOL / DRY	HEAT	Wired type	18~29	18~29	Wireless type	18~30	16~30	SET DATA	0	2	4	6	Temperature setting adjustment	+0 °C	+2 °C	+4 °C	+6 °C	Model type	SET DATA	Floor standing (standard, concealed, cabinet)	0	Other model	2	Shift in heating suction temperature (not applicable to remote controller thermo operation)
	COOL / DRY	HEAT																										
Wired type	18~29	18~29																										
Wireless type	18~30	16~30																										
SET DATA	0	2	4	6																								
Temperature setting adjustment	+0 °C	+2 °C	+4 °C	+6 °C																								
Model type	SET DATA																											
Floor standing (standard, concealed, cabinet)	0																											
Other model	2																											
4	Automatic capacity control	<ol style="list-style-type: none"> 1. The outdoor unit determines the operational capacities of indoor units according to the difference between Ta and Ts. <div style="display: flex; justify-content: space-around; margin-left: 40px;"> <div style="text-align: center;"> <p>Cooling</p> </div> <div style="text-align: center;"> <p>Heating</p> </div> </div>	Ts: Temperature setting Ta: Room temperature																									

NO.	Item	Specification outline	Remarks
5	Fan speed control	<p>1. The fan operates in one of the four speed modes of "HIGH (HH)", "MED (H)", "LOW (L)" and "AUTO" on the basis of a command issued via the remote controller. (Concealed duct high static pressure type: HH only)</p> <p>2. In AUTO fan speed mode, the air speed changes according to the difference between Ta and Ts.</p> <p><Cooling></p>  <p>The graph shows air temperature Ta (°C) on the y-axis ranging from -0.5 to +3.0. A horizontal line at Tsc represents the setpoint. The fan speed mode transitions are as follows: <ul style="list-style-type: none"> At Ta = +3.0, mode is HH <HH> (Boundary A) At Ta = +2.5, mode is H <HH> (Boundary B) At Ta = +2.0, mode is H+ <HH> (Boundary C) At Ta = +1.5, mode is L+ <H+> (Boundary D) At Ta = +1.0, mode is L <H> (Boundary E) At Ta = Tsc, mode is L <H> (Boundary F) At Ta = -0.5, mode is L <L+> (Boundary G) </p> <ul style="list-style-type: none"> Control is identical in remote controller thermo and body thermo operation. Speed modes shown in < > apply to cooling operation under AUTO air conditioner operation mode. In AUTO fan speed mode, the fan speed remains the same for 3 minutes each time a speed change occurs. However, a speed change command issued via the remote controller can override this, and the fan speed changes accordingly. At the beginning of cooling operation, a higher speed (steeper downward temperature gradient) is chosen. As long as the temperature difference remains on a boundary line, the fan speed stays the same. <p><Heating></p>  <p>The graph shows air temperature Ta (°C) on the y-axis ranging from -1.0 to +4.0. A horizontal line at Tsh represents the setpoint. The fan speed mode transitions are as follows: <ul style="list-style-type: none"> At Ta = -1.0, mode is L <L+> (Boundary A) At Ta = 0, mode is L+ <H> (Boundary E) At Ta = +1.0, mode is H <H+> (Boundary D) At Ta = +2.0, mode is H+ <HH> (Boundary C) At Ta = +3.0, mode is HH <HH> (Boundary B) At Ta = +4.0, mode is HH <HH> (Boundary A) </p> <p>Figures inside () applies to remote controller thermo operation. Figures outside () applies to body thermo operation. Speed modes shown in < > apply to heating operation under AUTO air conditioner operation mode.</p> <ul style="list-style-type: none"> In AUTO fan speed mode, the fan speed remains the same for 1 minute each time a speed change occurs. However, a speed change command issued via the remote controller can override this, and the fan speed changes accordingly. At the beginning of heating operation, a higher speed (steeper upward temperature gradient) is chosen. As long as the temperature difference remains on a boundary line, the fan speed stays the same. When TC2 ≥ 60 °C, the fan speed is raised by one step. <p>3. If the air conditioner goes thermo OFF during heating operation, the fan speed drops down to LL (breeze).</p>	<p>HH > H+ > H > L+ > L > UL or LL</p> <p>DN code "32" "0000": Body thermo "0001": Remote controller thermo</p> <p>TC2: Indoor heat exchanger sensor temperature</p> <p>"HEATING STANDBY"  displayed</p>

NO.	Item	Specification outline	Remarks															
6	Cold air discharge prevention control	<p>1. In heating operation, the upper limit of the fan tap is set according to the lower of whichever is the higher between TC2 sensor and TCJ sensor temperatures, on the one hand, and TC1 sensor temperature, on the other.</p> <ul style="list-style-type: none"> • If the fan continuously operates in zone B for 6 minutes, it automatically moves into zone C. • During defrosting, the control point is shifted by +6 °C. <p>A zone: OFF B zone: 26°C or above and below 28°C breeze C zone: 28°C or above and below 30°C Low D zone: 30°C or above and below 32°C Medium E zone: High</p>	<p>TCJ: Indoor heat exchanger sensor temperature</p> <ul style="list-style-type: none"> • In zones D and E, priority is given to the remote controller fan speed setting. • In zone A, "HEATING STANDBY" is displayed. 															
7	Freeze prevention control (low temp. release)	<p>1. During cooling, the air conditioner is operated in the manner described below according to the temperature readings of the TC1, TC2 and TCJ sensors.</p> <ul style="list-style-type: none"> • If zone J operation is detected for 5 minutes, the air conditioner is forced into thermo OFF. • In zone K, the timer is put on pause, with the current timer count retained. • If zone I operation is detected, the timer count is cleared, and the air conditioner returns to normal operation. • If continuous zone J operation forces the air conditioner into thermo OFF, the indoor fan is operated in breeze mode until it moves into zone I. The control is terminated under the following conditions: <p>Termination conditions</p> <p>1) TC1 ≥ 12 °C, TC2 ≥ 12 °C, and TCJ ≥ 12 °C</p> <table border="1" data-bbox="751 1196 1066 1290"> <thead> <tr> <th></th> <th>TC1</th> <th>TC2, TCJ</th> </tr> </thead> <tbody> <tr> <td>P1</td> <td>10°C (5°C)</td> <td>-10°C</td> </tr> <tr> <td>Q1</td> <td>0°C</td> <td>-14°C</td> </tr> </tbody> </table> <p>2) Passage of 20 minutes after stoppage</p> <p>2. During cooling, the air conditioner is operated in the manner described below according to the temperature readings of the TC2 and TCJ sensors.</p> <ul style="list-style-type: none"> • If zone M operation is detected for 45 minutes, the air conditioner is forced into thermo OFF. • In zone N, the timer is put on pause, with the current timer count retained. • When the air conditioner goes back into zone M, timer count is resumed from the retained value. <table border="1" data-bbox="751 1664 938 1758"> <thead> <tr> <th></th> <th>TC2, TCJ</th> </tr> </thead> <tbody> <tr> <td>P2</td> <td>5</td> </tr> <tr> <td>Q2</td> <td>-2.0</td> </tr> </tbody> </table> <ul style="list-style-type: none"> • If zone L operation is detected, the timer count is cleared, and the air conditioner returns to normal operation. <p>Reset conditions</p> <p>1) TC1 ≥ 12 °C, TC2 ≥ 12 °C and TCJ ≥ 12 °C</p> <p>2) Passage of 20 minutes after stoppage</p>		TC1	TC2, TCJ	P1	10°C (5°C)	-10°C	Q1	0°C	-14°C		TC2, TCJ	P2	5	Q2	-2.0	<p>TC1: Indoor heat exchanger sensor temperature</p> <p>* With models without TC2, TC2 is not part of the control parameters.</p>
	TC1	TC2, TCJ																
P1	10°C (5°C)	-10°C																
Q1	0°C	-14°C																
	TC2, TCJ																	
P2	5																	
Q2	-2.0																	

NO.	Item	Specification outline	Remarks
8	Cooling oil (refrigerant) recovery control	<p>While the outdoor unit is recovering cooling oil (refrigerant), the indoor units perform the following control tasks: [common for operational (cooling thermo ON / thermo OFF / FAN), as well as nonoperational indoor units]</p> <ol style="list-style-type: none"> 1) Open the indoor PMV to a certain degree. 2) Engage in recovery control for a specified period of time and return to normal cooling operation at the end of this period upon terminating the control. 3) Operate the drain pump throughout the recovery control period and for about 1 minute after it. 	<ul style="list-style-type: none"> • Recovery operation normally takes place roughly every 2 hours. • The opening position of the indoor PMV depending on the type and capacity of the indoor unit.
9	Heating refrigerant (oil) recovery control	<p>While the outdoor unit is recovering heating refrigerant (oil), the indoor units perform the following control tasks:</p> <ol style="list-style-type: none"> 1) Open the indoor PMV to a certain degree. 2) Control the indoor fan according to the operation mode. [Indoor units operating in heating thermo ON / OFF state] Let the indoor fan continue operating, but turn it off if the temperature of the indoor heat exchanger drops. [Indoor units operating in FAN mode] Turn off the indoor fan and display “HEATING STANDBY  ” on the remote controller. [Non-operational indoor units] Keep the indoor fan turned off. 3) Terminate the recovery operation depending on the TC2 temperature reading. The timing of termination is determined by each indoor unit. 4) Operate the indoor fan and drain pump for about 1 minute after the termination of the recovery operation. (Applicable to compact 4-way cassette type and 1-way cassette type) 	<ul style="list-style-type: none"> • Recovery operation normally takes place roughly every hour. • The opening position of the indoor PMV depending on the type and capacity of the indoor unit.
10	Defrosting control	<p>While the outdoor unit is engaged in defrosting control, the indoor units perform the following control tasks:</p> <ol style="list-style-type: none"> 1) Open the indoor PMV to a certain degree. 2) Control the indoor fan according to the operation mode. [Indoor units operating in heating thermo ON / OFF state] Let the indoor fan continue operating for a while, but turn it off as the temperature of the indoor heat exchanger drops. [Indoor units operating in FAN mode] Let the indoor fan continue operating. [Non-operational indoor units] Keep the indoor fan turned off. 3) As defrosting control comes to an end, it gives way to heating refrigerant (oil) recovery control. (For control details, see “9. Heating refrigerant (oil) recovery control” above.) 	<ul style="list-style-type: none"> • For defrosting commencement conditions, see 5 Control Outline “10. Defrosting control (reverse defrosting method)” in SMMS-i Outdoor Unit Service Manual A10-005 above. • The opening position of the indoor PMV depending on the type and capacity of the indoor unit.
11	Short intermittent operation compensation control	<ol style="list-style-type: none"> 1. For 5 minutes after startup, the system is forced to continue operating even if it reaches the thermo OFF region. 2. However, priority is given to cooling / heating selection, operation standby, and protective control, so that there is no overriding of thermo OFF in these cases. 	
12	Drain pump control	<ol style="list-style-type: none"> 1. During cooling (including DRY operation), the drain pump is operated at all times. 2. If the float switch is activated while the drain pump is in operation, the drain pump continues operating, with the relevant check code displayed. 3. If the float switch is activated while the drain pump is turned off, thermo OFF is forced on the air conditioner, with the drain pump put into operation. If the float switch continues to be activated for about 5 minutes, the drain pump is turned off, with the relevant check code displayed. 	Check code [P10]
13	Elimination of residual heat	<ol style="list-style-type: none"> 1. When the air conditioner is turned off after engaging in heating operation, the indoor fan is operated for about 30 seconds in “breeze” mode. 	

NO.	Item	Specification outline	Remarks																																																		
14	Filter sign display (not applicable to wireless type) *Provided in the separately mounted type, TCB-AX21E.	<p>1. The indoor fan's cumulative hours of operation are counted, and when these exceed the prescribed value (2500H), a filter replacement signal is sent to the remote controller to display a filter sign on it.</p> <p>2. When a filter reset signal is received from the remote controller, the timer measuring cumulative hours is cleared. If the prescribed hours have been exceeded, the hours count is reset, with the sign on the remote controller display erased.</p> <table border="1" style="margin-left: auto; margin-right: auto;"> <tr> <td>Filter service life</td> <td>2500H</td> </tr> </table>	Filter service life	2500H	"FILTER  " displayed																																																
Filter service life	2500H																																																				
15	Operation standby Heating standby	<p><Operation standby> Displayed on remote controller</p> <ol style="list-style-type: none"> When any of the DN codes listed below is displayed <ul style="list-style-type: none"> "P05" - Detection of an open phase in the power supply wiring "P10" - Detection of indoor flooding in at least one indoor unit "L30" - Detection of an interlock alarm in at least one indoor unit Forced thermo OFF <ul style="list-style-type: none"> "COOL / DRY" operation is unavailable because at least one indoor unit is operating in "HEAT" mode. "HEAT" operation is unavailable because at least one indoor unit is operating in "COOL / DRY" mode under priority cooling setting (bit 1 of SW11 on outdoor I/ F P.C. board ON). All indoor units not able to engage in any of the above operations stand by in thermo OFF state. The indoor fan has been turned off because the system is engaged in a heat refrigerant (oil) recovery operation. <p><Heating standby> Displayed on remote controller</p> <ol style="list-style-type: none"> Normal thermo OFF <ul style="list-style-type: none"> During heating, the indoor unit goes thermo OFF as the heating temperature setting is reached. During heating, the fan rotates at a breeze speed (UL or lower) or remains stationary to prevent cold air from being discharged (including defrosting operation). Forced thermo OFF <ul style="list-style-type: none"> "HEAT" operation is unavailable because at least one indoor unit is operating in "COOL / DRY" mode under priority cooling setting (bit 1 of SW11 on outdoor I/ F P.C. board ON). 	<ul style="list-style-type: none"> "OPERATION STANDBY  " displayed No display provided on wireless remote controller "HEATING STANDBY  " displayed 																																																		
16	Selection of central control mode	<p>1. The range of operations that can be performed via an indoor unit remote controller can be determined through the setting of the central controller.</p> <p>2. Setting details</p> <p>TCC-Link central control</p> <table border="1" style="margin-left: auto; margin-right: auto;"> <thead> <tr> <th rowspan="2">Operation via TCCLink central control</th> <th colspan="6">Operation on RBC-AMT32E</th> <th rowspan="2">RBC-AMT32E display</th> </tr> <tr> <th>Start / stop selection</th> <th>Operation mode selection</th> <th>Timer setting</th> <th>Temperature setting</th> <th>Fan speed setting</th> <th>Air flow direction setting</th> </tr> </thead> <tbody> <tr> <td>Individual</td> <td>○</td> <td>○</td> <td>○</td> <td>○</td> <td>○</td> <td>○</td> <td rowspan="5">"CENTRAL CONTROL IN PROGRESS" </td> </tr> <tr> <td>Central 1</td> <td>×</td> <td>○</td> <td>×</td> <td>○</td> <td>○</td> <td>○</td> </tr> <tr> <td>Central 2</td> <td>×</td> <td>×</td> <td>×</td> <td>×</td> <td>○</td> <td>○</td> </tr> <tr> <td>Central 3</td> <td>○</td> <td>×</td> <td>○</td> <td>×</td> <td>○</td> <td>○</td> </tr> <tr> <td>Central 4</td> <td>○</td> <td>×</td> <td>○</td> <td>○</td> <td>○</td> <td>○</td> </tr> </tbody> </table> <p>(○ : Accessible × : Inaccessible)</p>	Operation via TCCLink central control	Operation on RBC-AMT32E						RBC-AMT32E display	Start / stop selection	Operation mode selection	Timer setting	Temperature setting	Fan speed setting	Air flow direction setting	Individual	○	○	○	○	○	○	"CENTRAL CONTROL IN PROGRESS" 	Central 1	×	○	×	○	○	○	Central 2	×	×	×	×	○	○	Central 3	○	×	○	×	○	○	Central 4	○	×	○	○	○	○	<ul style="list-style-type: none"> In the case of a wired remote controller, "CENTRAL CONTROL IN PROGRESS  " is displayed (lit up) while in central control mode. The display blinks when a control function inaccessible to a remote controller is chosen. A wireless remote controller has the same set of control functions, although there is no display. When a control operation is performed via a wireless remote controller while in central control mode, a peep sound alert (5 times) is provided.
Operation via TCCLink central control	Operation on RBC-AMT32E						RBC-AMT32E display																																														
	Start / stop selection	Operation mode selection	Timer setting	Temperature setting	Fan speed setting	Air flow direction setting																																															
Individual	○	○	○	○	○	○	"CENTRAL CONTROL IN PROGRESS" 																																														
Central 1	×	○	×	○	○	○																																															
Central 2	×	×	×	×	○	○																																															
Central 3	○	×	○	×	○	○																																															
Central 4	○	×	○	○	○	○																																															

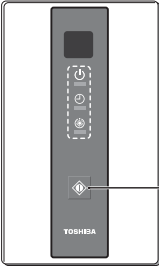
NO.	Item	Specification outline	Remarks
17	DC motor	1) When the fan operation has started, positioning of the stator and the rotor are performed. (Moves slightly with tap sound) 2) The motor operates according to the command from the indoor controller. Notes) <ul style="list-style-type: none"> • When the fan rotates while the air conditioner stops due to entering of outside air, etc, the air conditioner may operate while the fan motor stops. • When a fan lock is found, the air conditioner stops, and an error is displayed. • If static pressure of the used duct does not match with the setup value of static pressure, which was decided in the static pressure setting code No. [5D], the air conditioner may stop or an error code may be displayed. 	Check code "P12"
18	Power saving mode	1. Push the  button on the remote controller 2. The "  " segment lights up on the wired remote controller display. 3. The requirement capacity ratio is limited to approximately 75 %. 4. If the power saving operation is enabled, the settings are retained when the operation is stopped, when the mode is changed, or when the power is reset. The power saving operation will be enabled the next time the operation starts.	The power saving operation cannot be set by the wireless remote controller or wired remote controller of AMT31E or older.
19	Frequency fixed operation (Test run)	<p><In case of wired remote controller></p> 1) When pushing [CHK] button for 4 seconds or more, [TEST] is displayed on the display screen and the mode enters in Test run mode. 2) Push [ON/OFF] button. 3) Using [MODE] button, set the mode to [COOL] or [HEAT]. <ul style="list-style-type: none"> • Do not use other mode than [COOL]/[HEAT] mode. • During test run operation, the temperature cannot be adjusted. • An error is detected as usual. • A frequency fixed operation is performed. 4) After the test run, push [ON/OFF] button to stop the operation. (Display in the display part is same as the procedure in Item 1.) 5) Push [CHK] button to clear the test run mode. ([TEST] display in the display part disappears and the status returns to the normal stop status.) <p><In case of wireless remote controller></p> 1) When TEMPORARY button is pushed for 10 seconds or more, "Pi!" sound is heard and the operation changes to test run. After approx. 3 minutes, a cooling operation starts forcibly. Check cool air starts blowing. If the operation does not start, check wiring again. 2) To stop a test operation, push TEMPORARY button once again (Approx. 1 second). Check wiring / piping of the indoor and outdoor units in test run. <div style="text-align: center; margin-top: 20px;">  <p>TEMPORARY button</p> </div>	Command frequency is approximately [S7]

8. APPLIED CONTROL AND FUNCTIONS (INCLUDING CIRCUIT CONFIGURATION)

8-1. Indoor controller block diagram

8-1-1. In Case of Connection of Wired (Simple) Remote Controller

<Concealed Duct Standard type>

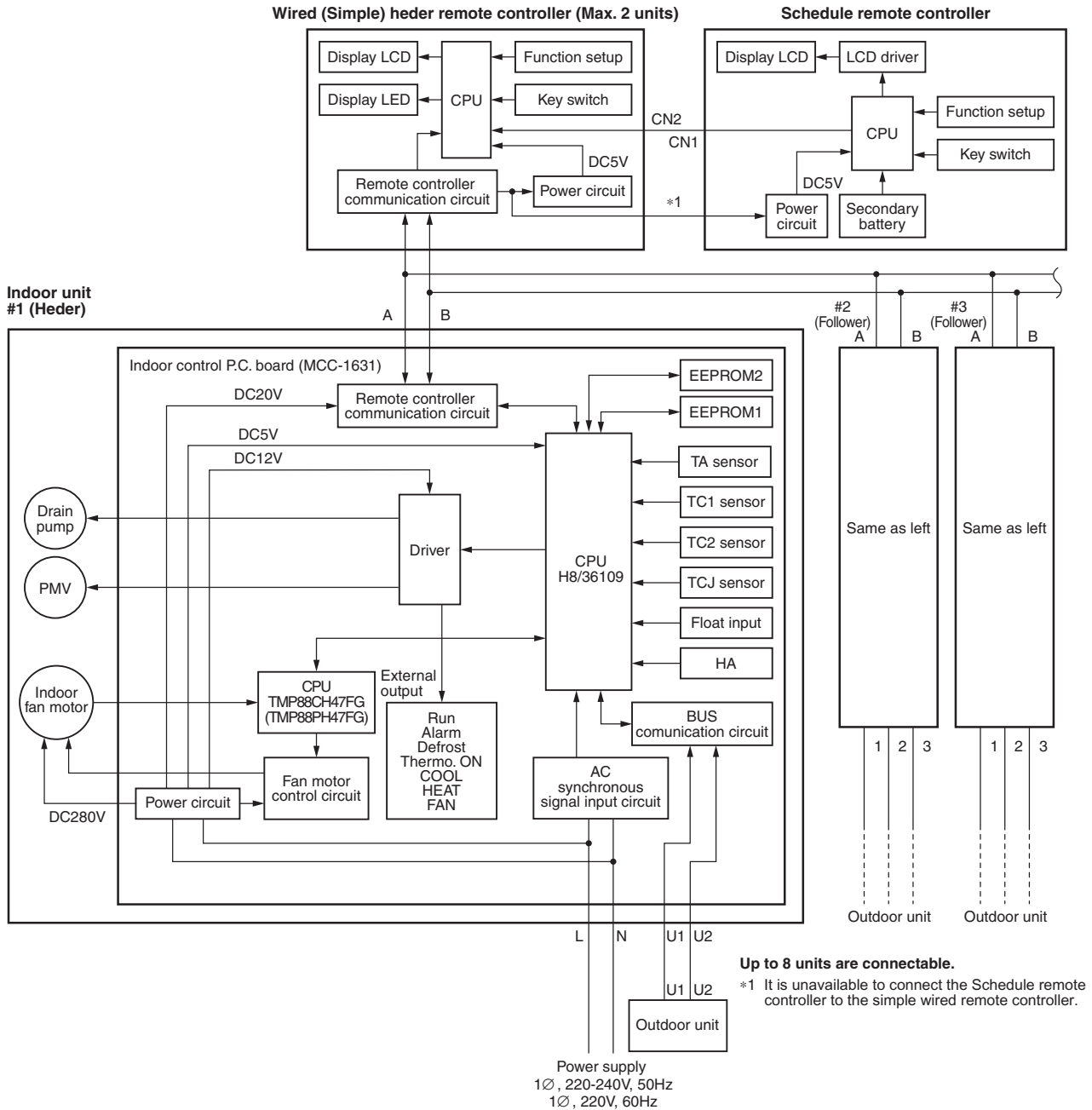

8-1-2. In Case of Connection of Wireless Remote Controller <Concealed Duct Standard type>

Indoor unit
#1 (Header)

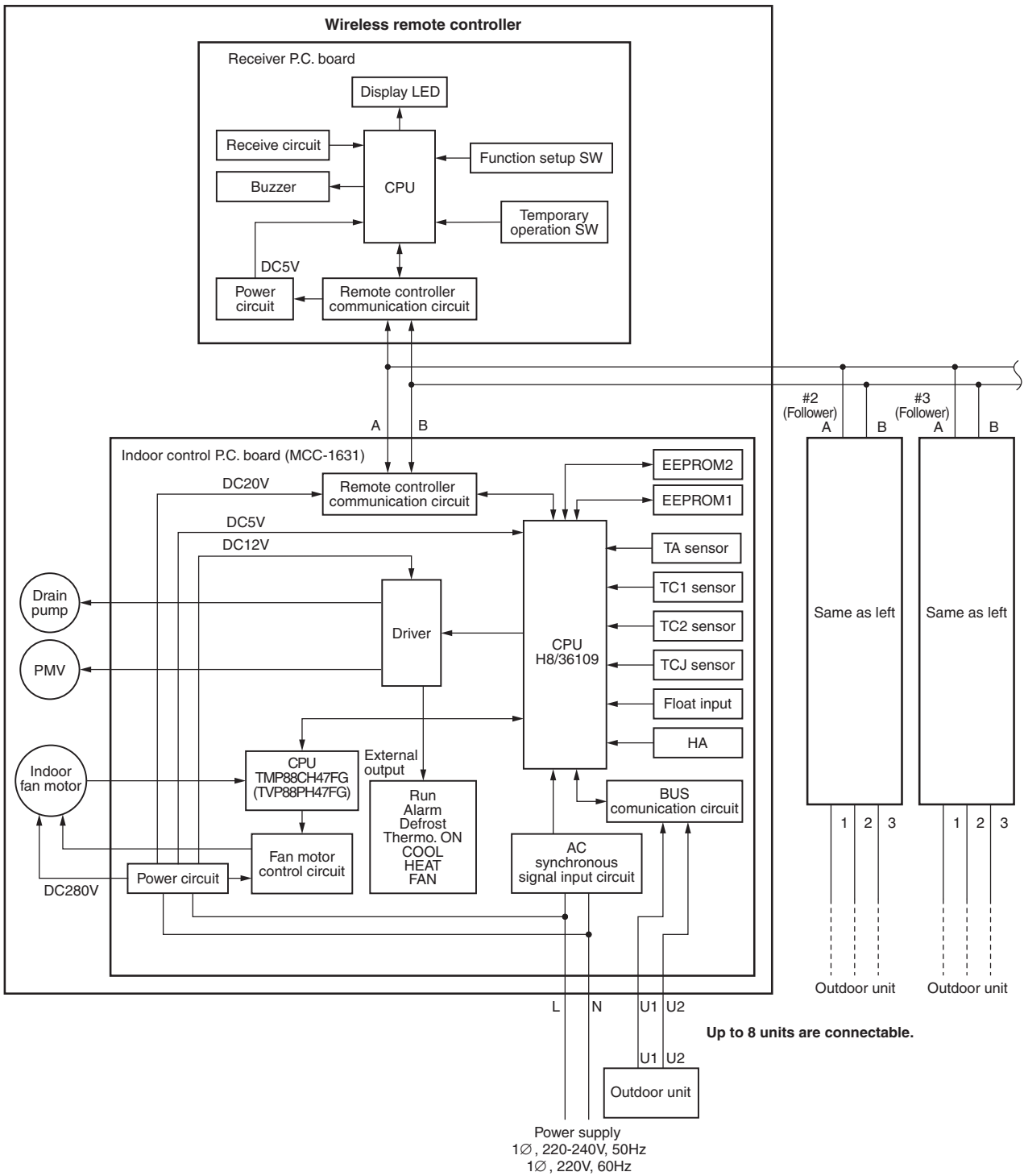

8-1-3. Connection of Both Wired (Simple) Remote Controller and Wireless Remote Controller <Concealed Duct Standard type>

Indoor unit
#1 (Header)

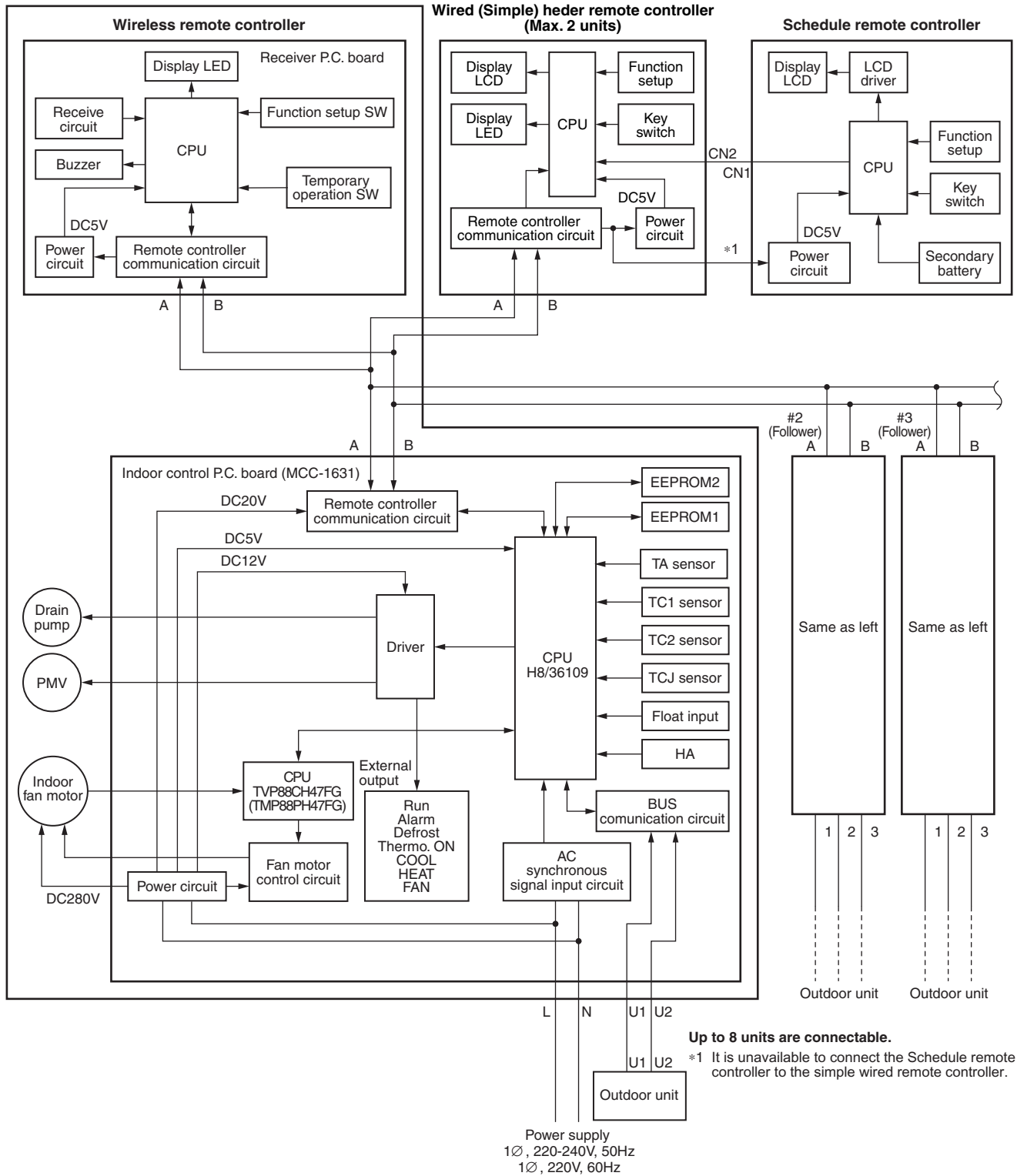

8-2. Indoor Print Circuit Board

MCC-1631 <Concealed duct standard type>

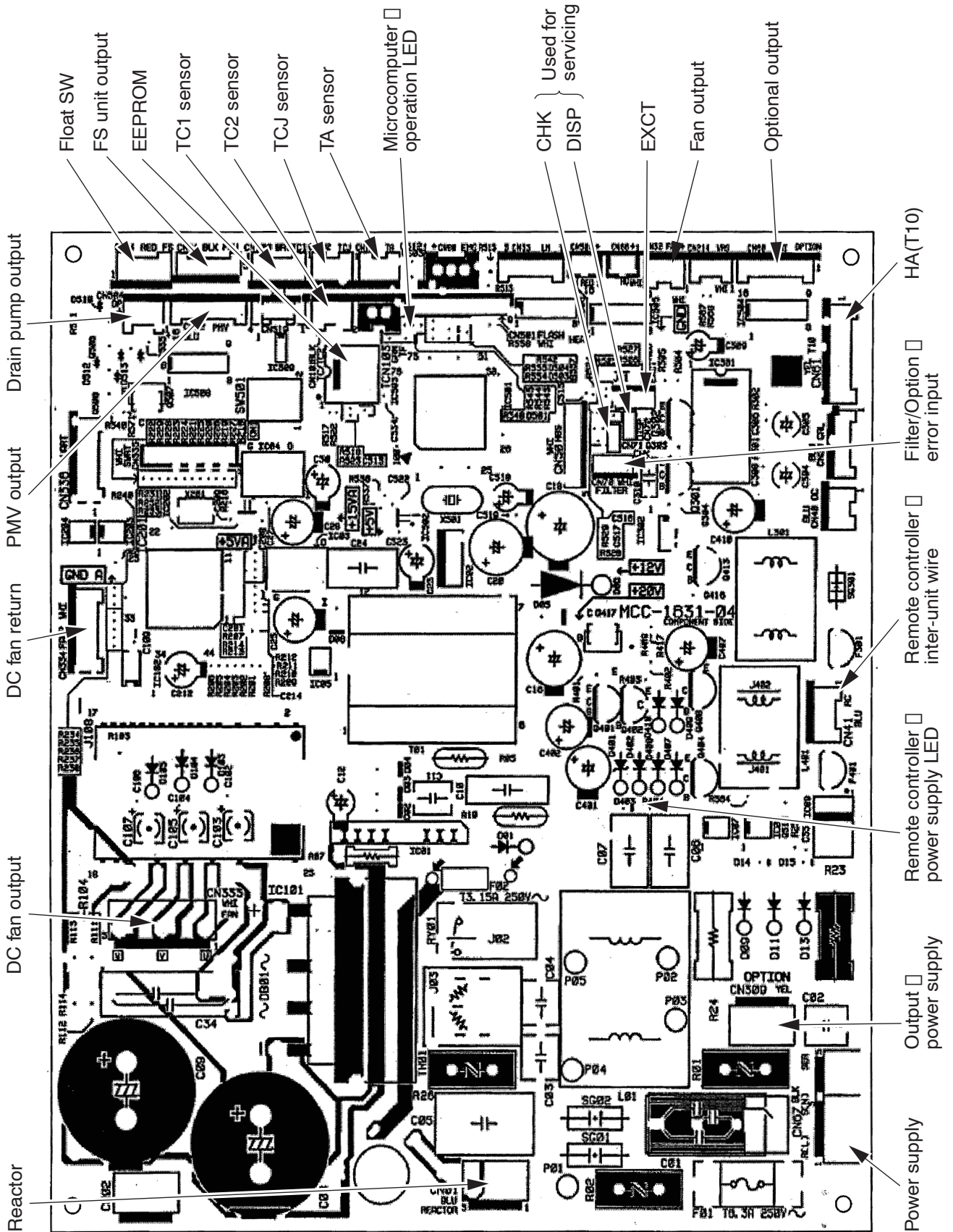

8-3. Optional connector specifications of indoor P.C. board

Function	Connector No.	Pin No.	Specification	Remarks
Fan output	CN32	1	DC12 V	Factory default setting: ON when indoor unit in operation and OFF when indoor unit at rest * Fan can be operated on its own by pressing FAN button on remote controller (DN = 31)
		2	Output	
HA	CN61	1	Start / stop input	Start / stop input for HA (J01: In place / Removed = Pulse input (factory default) / Step input)
		2	0 V (COM)	
		3	Remote controller disabling input	Enables / disables start / stop control via remote controller
		4	In-operation output	ON during operation (HA answerback signal)
		5	DC12 V (COM)	
		6	Alarm output	ON while alarm ON
Optional output	CN60	1	DC12 V (COM)	
		2	Defrosting output	ON while outdoor unit defrosted
		3	Thermostat ON output	ON while real thermostat ON (compressor ON)
		4	Cooling output	ON while air conditioner in cooling or related operation (COOL, DRY or cooling under AUTO mode)
		5	Heating output	ON while air conditioner in heating operation (HEAT or heating under AUTO mode)
		6	Fan output	ON while indoor fan ON (air cleaner in use or via interlock wiring)
External error input	CN80	1	DC12 V (COM)	Generates test code L30 and automatically shuts down air conditioner (only if condition persists for 1 minute)
		2	DC12 V (COM)	
		3	External error input	
CHK Operation check	CN71	1	Check mode input	Used for indoor operation check (prescribed operational status output, such as indoor fan "H" or drain pump ON, to be generated without communication with outdoor unit or remote controller)
		2	0 V	
DISP Display mode	CN72	1	Display mode input	Product display mode - Communication just between indoor unit and remote controller enabled (upon turning on of power) Timer short-circuited out (always)
		2	0 V	
EXCT Demand	CN73	1	Demand input	Imposes thermostat OFF on indoor unit
		2	0 V	

8-4. Test operation of indoor unit

▼ Check function for operation of indoor unit (Functions at indoor unit side)

This function is provided to check the operation of the indoor unit singly without communication with the remote controller or the outdoor unit. This function can be used regardless of operation or stop of the system. However, if using this function for a long time, a trouble of the equipment may be caused. Limit using this function within several minutes.

[How to operate]

- 1) Short-circuit CHK pin (CN71 on the indoor P.C. board).
The operation mode differs according to the indoor unit status in that time.
Normal time: Both float SW and fan motor are normal.
Abnormal time: Either one of float SW or fan motor is abnormal.
- 2) Restricted to the normal time, if short-circuiting DISP pin (CN72 on the indoor P.C. board) in addition to short-circuit of CHK pin (CN71 on the indoor P.C. board), the minimum opening degree (30 pls) can be set to the indoor PMV only.
When open DISP pin, the maximum opening degree (1500 pls) can be obtained again.

[How to clear]

Open CHK pin. While the system is operating, it stops once but automatically returns to operation after several minutes.

	Short-circuit of CHK pin		
	Normal time		Abnormal time
	DISP pin open	DISP pin short circuit	
Fan motor	(H)	(H)	Stop
Indoor PMV (*)	Max. opening degree (1500 pls)	Min. opening degree (30 pls)	Min. opening degree (30 pls)
Louver	Horizontal	Horizontal	Immediate stop
Drain pump	ON	ON	ON
Communication	All ignored	All ignored	All ignored
P.C. board LED	Lights	Lights	Flashes

- To exchange the indoor PMV coil, set the indoor PMV to Max. opening degree.
- For the detailed positions of CHK pin (CN71 on indoor P.C. board) and DISP pin (CN72 on indoor P.C. board), refer to the indoor P.C. board.

8-5. Method to set indoor unit function DN code

(When performing this task, be sure to use a wired remote controller.)

<Procedure> To be performed only when system at rest

- 1 Push the  +  +  buttons simultaneously and hold for at least 4 seconds.

The unit No. displayed first is the address of the header indoor unit in group control.

Then the fan and louver of the selected indoor unit move.

- 2 Each time the  button (left side of the button) is pressed, one of the indoor unit Nos. under group control is displayed in turn. Then the fan and louver of the selected indoor unit move.

- 3 Use the  button to select the CODE No. (DN code) of the desired function.

- 4 Use the  button to select the desired SET DATA associated with the selected function.

- 5 Push the  button. (The display changes from flashing to steady.)

- To change the selected indoor unit, go back to step 2.
- To change the selected function, go back to step 3.

- 6 When the  button is pushed, the system returns to normal off state.

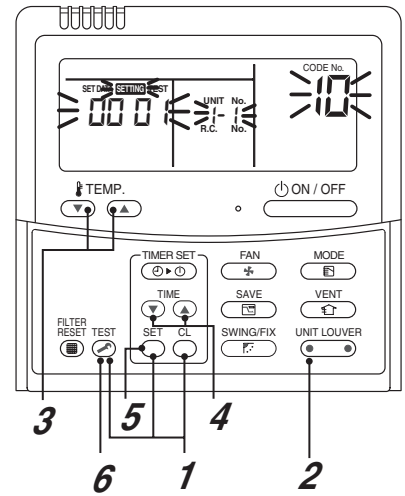

Function CODE No. (DN Code) table (includes all functions needed to perform applied control on site)

DN	Item	Description	At shipment						
01	Filter display delay timer	0000: None 0002: 2500H 0004: 10000H 0001: 150H 0003: 5000H	According to type						
02	Dirty state of filter	0000: Standard 0001: High degree of dirt (Half of standard time)	0000: Standard						
03	Central control address	0001: No.1 unit to 0064: No.64 unit 0099: Unfixed	0099: Unfixed						
04	Specific indoor unit priority	0000: No priority 0001: Priority	0000: No priority						
06	Heating temp shift	0000: No shift to 0001: +1 C 0002: +2 C to 0010: +10 C (Up to +6 recommended)	0002: +2 C (Floor type 0000: 0 C)						
0d	Existence of [AUTO] mode	0000: Provided 0001: Not provided (Automatic selection from connected outdoor unit)	0001: Not provided						
0F	Cooling only	0000: Heat pump 0001: Cooling only (No display of [AUTO] [HEAT])	0000: Heat pump						
10	Type	0001: 4-way Cassette etc. * refer to 36 page Type CODE No. [10]	Depending on model type						
11	Indoor unit capacity	0000: Unfixed 0001 to 0034	According to capacity type						
12	Line address	0001: No.1 unit to 0030: No.30 unit	0099: Unfixed						
13	Indoor unit address	0001: No.1 unit to 0064: No.64 unit	0099: Unfixed						
14	Group address	0000: Individual 0002: Follower unit of group 0001: Header unit of group	0099: Unfixed						
1E	Temp difference of [AUTO] mode selection COOL → HEAT, HEAT → COOL	0000: 0 deg to 0010: 10 deg (For setup temperature, reversal of COOL / HEAT by } (Data value) / 2)	0003: 3 deg (Ts ±1.5)						
28	Automatic restart of power failure	0000: None 0001: Restart	0000: None						
2A	Selection of option / error input (CN70)	0000: Filter input 0002: None 0001: Alarm input (Air washer, etc.)	0002: None						
2E	HA terminal (CN61) select	0000: Usual 0002: Fire alarm input 0001: Leaving-ON prevention control	0000: Usual (HA terminal)						
31	Ventilating fan control	0000: Unavailable 0001: Available	0000: Unavailable						
32	TA sensor selection	0000: Body TA sensor 0001: Remote controller sensor	0000: Body TA sensor						
33	Temperature unit select	0000: C (at factory shipment) 0001: F	0000: C						
5d	Static pressure selection	0000: Standard							
		Set data	0000	0001	0002	0003	0004	0005	0006
		External static pressure	40 Pa AP024 ~ 030 (Factory default)	30 Pa AP007 ~ 018 (Factory default)	65 Pa	50 Pa AP036 ~ 056 (Factory default)	80 Pa	100 Pa	120 Pa
The list above is when SW501-1 and SW501-2 is OFF.									
60	Timer setting (wired remote controller)	0000: Available (can be performed) 0001: Unavailable (cannot be performed)	0000: Available						
92	External interlock release condition	0000: Operation stopped 0001: Release signal received	0000: Operation stopped						
D0	Whether the power saving mode can be set by the remote controller	0000: Invalid 0001: Valid	0001: Valid						

**Type
DN code “10”**

Value	Type	Model
0004	Concealed Duct Standard	MMD-AP***BHP11

**Indoor Unit Capacity
DN code “11”**

Value	Capacity
0000*	Invalid
0001	007 type
0003e	009 type
0005	012 type
0007	015 type
0009	018 type
0011	024 type
0012	027 type
0013	030 type
0015	036 type
0017	048 type
0018	056 type
0021	072 type
0023	096 type
~	

*1 Default value stored in EEPROM mounted on service P.C. board

8-6. Applied control of indoor unit

Control system using remote controller interface (TCB-IFCB4E2)

Wiring and setting

- In the case of group control, the control system functions as long as it is connected to one of the indoor units (control P.C. board) in the group. If it is desired to access the operation and error statuses of other units, relevant signals must be brought to it from those units individually.

▼ Control items

- | | |
|-------------------------------|---|
| (1) Start / Stop input signal | Start / stop of unit |
| (2) In-operation signal | Output present while unit in normal operation |
| (3) Error signal Output | present while alarm (e.g. serial communication error or operation of protective device for indoor / outdoor unit) being activated |

▼ Wiring diagram of control system using remote controller interface (TCB-IFCB4E2)

- Input IFCB4E2: No-voltage ON / OFF serial signal
- Output No-voltage contact (in-operation and error indication)
Contact capacity: Max. AC 240 V, 0.5 A

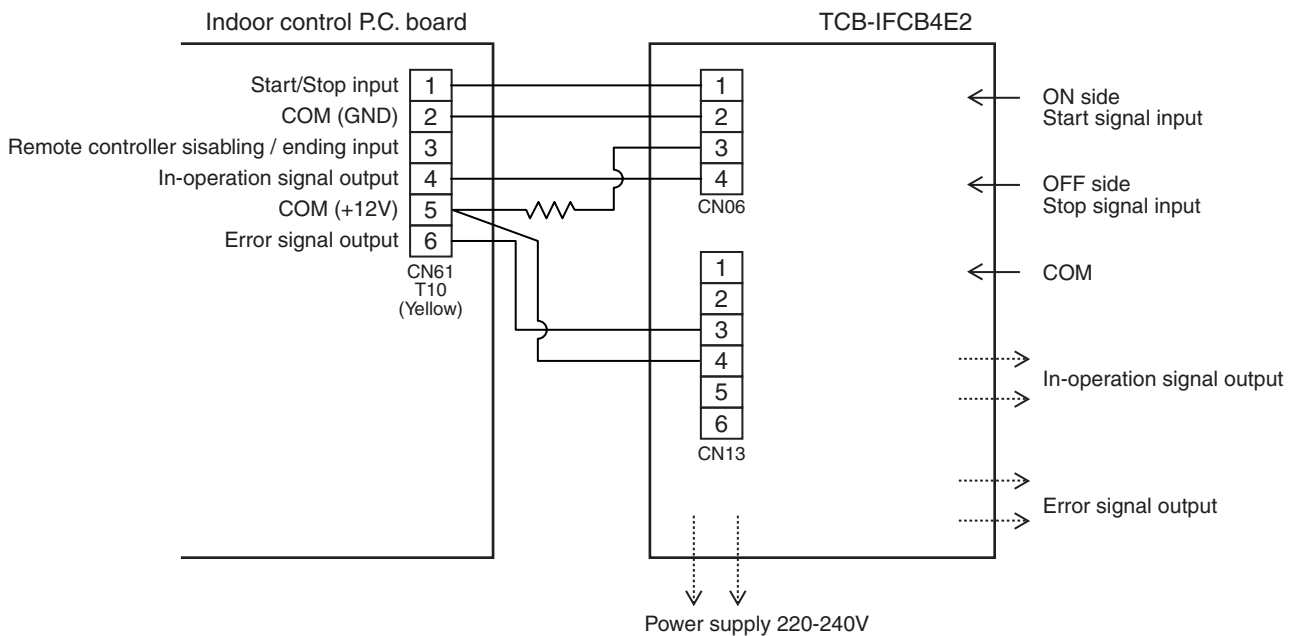

▼ Ventilating fan control from remote controller

[Function]

- The start / stop operation can be operated from the wired remote controller when air to air heat exchanger or ventilating fan is installed in the system.
- The fan can be operated even if the indoor unit is not operating.
- Use a fan which can receive the no-voltage A contact as an outside input signal.
- In a group control, the units are collectively operated and they can not be individually operated.

1. Operation

Handle a wired remote controller in the following procedure.

- * Use the wired remote controller during stop of the system.
- * Be sure to set up the wired remote controller to the header unit. (Same in group control)
- * In a group control, if the wired remote controller is set up to the header unit, both header and follower units are simultaneously operable.

1 Push concurrently + + buttons for 4 seconds or more.

The unit No. displayed firstly indicates the header indoor unit address in the group control. In this time, the fan of the selected indoor unit turns on.

2 Every pushing button (left side of the button), the indoor unit numbers in group control are displayed successively.

In this time, the fan of the selected indoor unit only turns on.

3 Using the setup temp or button, specify the CODE No. 3 1.

4 Using the timer time or button, select the SET DATA. (At shipment: 0000)

The setup data are as follows:

SET DATA	Handling of operation of air to air heat exchanger or ventilating fan
0000	Unavailable (At shipment)
000 1	Available

5 Push button. (OK if display goes on.)

- To change the selected indoor unit, go to the procedure 2).
- To change the item to be set up, go to the procedure 3).

6 Pushing returns the status to the usual stop status.

2. Wiring

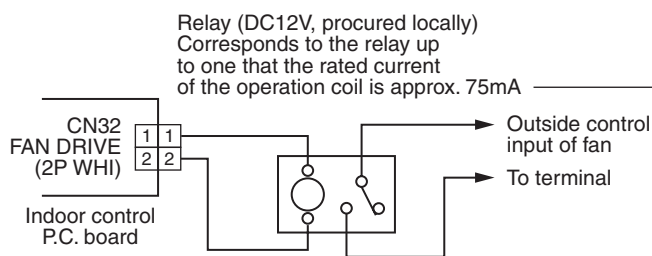

Note) Determine the cable length between the indoor control P.C. board and the relay within 2m.

Compact 4-way Cassette type
1-way Cassette type (SH)
Concealed Duct Standard type
Slim Duct type
Ceiling type
Corresponds up to a relay in which rated current of the operation coil is approx. 75 mA
Other type models:
Correspond up to a relay in which rated current of the operation coil is approx. 16 mA (Does not correspond to a terminal block type relay on the market.)

} model :

▼ Leaving-ON prevention control

[Function]

- This function controls the indoor units individually. It is connected with cable to the control P.C. board of the indoor unit.
- In a group control, it is connected with cable to the indoor unit (Control P.C. board), and the CODE No. **2E** is set to the connected indoor unit.
- It is used when the start operation from outside is unnecessary but the stop operation is necessary.
- Using a card switch box, card lock, etc, the forgotten-OFF of the indoor unit can be protected.
- When inserting a card, start / stop operation from the remote controller is allowed.
- When taking out a card, the system stops if the indoor unit is operating and start / stop operation from the remote controller is forbidden.

1. Control items









- 1) Outside contact ON: The start / stop operation from the remote controller is allowed.
(Status that card is inserted in the card switch box)
- 2) Outside contact OFF: If the indoor unit is operating, it is stopped forcibly.
(Start / Stop prohibited to remote controller)
(Status that card is taken out from the card switch box)

* When the card switch box does not perform the above contact operation, convert it using a relay with b contact.

2. Operation

Handle the wired remote controller switch in the following procedure.

* Use the wired remote controller switch during stop of the system.

- 1 Push concurrently  +  +  buttons for 4 seconds or more.**
- 2 Using the setup temp  or  button, specify the CODE No. **2E**.**
- 3 Using the timer time  or  button, set **000** to the SET DATA.**
- 4 Push  button.**
- 5 Push  button. (The status returns to the usual stop status.)**

3. Wiring

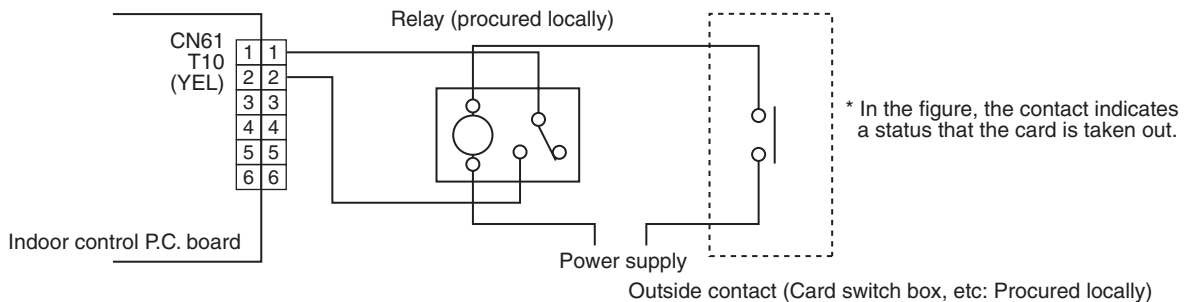

Note) Determine the cable length between the indoor control P.C. board and the relay within 2m.

▼ Power peak-cut from indoor unit

When the relay is turned on, a forced thermostat-OFF operation starts.

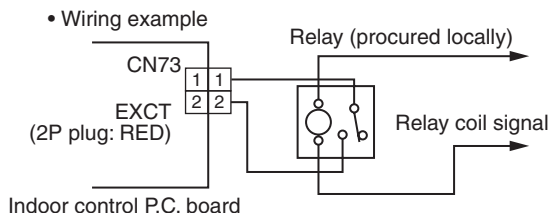

Note) Determine the cable length between the indoor or outdoor control P.C. board and the relay within 2m.

Manual address setting using the remote controller

Procedure when setting indoor units' addresses first under the condition that indoor wiring has been completed and outdoor wiring has not been started (manual setting using the remote controller)

▼ Wiring example of 2 refrigerant lines

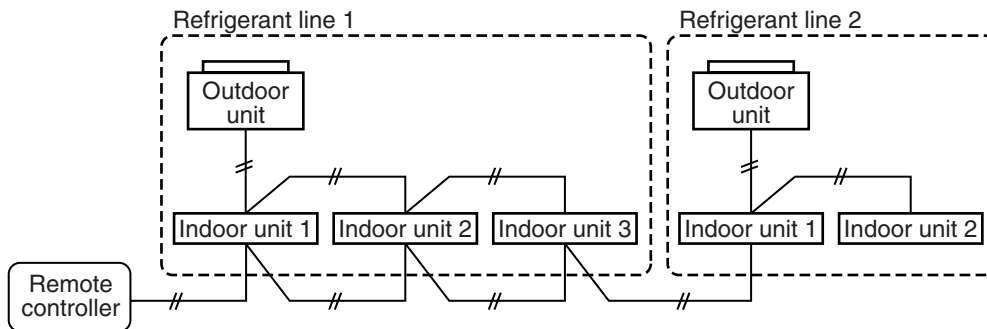

Line (system) address	1	1	1	2	2
Indoor unit address	1	2	3	1	2
Group address	1 Header unit	2 Follower unit	2 Follower unit	2 Follower unit	2 Follower unit

In the example above, disconnect the remote controller connections between the indoor units and connect a wired remote controller to the target unit directly before address setting.

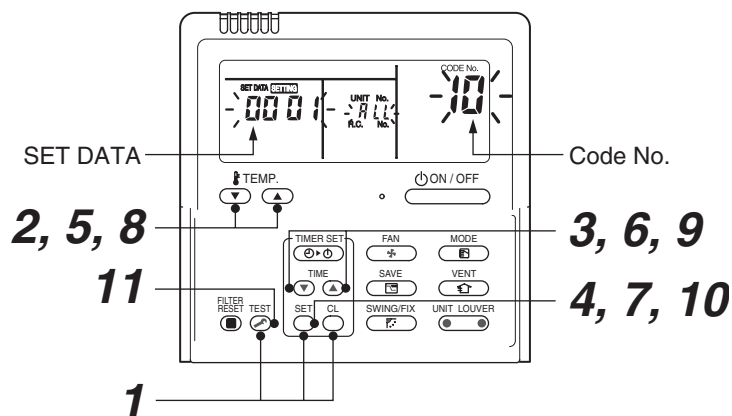

Pair the indoor unit to set and the remote controller one-to-one.

Turn on the power.

- 1 Push and hold the **SET**, **CL** and **TEST** buttons at the same time for more than 4 seconds. LCD starts flashing.







<Line (system) address>

- 2** Push the TEMP.  /  buttons repeatedly to set the CODE No. to **12**.
- 3** Push the TIME  /  buttons repeatedly to set a system address.
(Match the address with the address on the interface P.C. board of the header outdoor unit in the same refrigerant line.)
- 4** Push  button.
(It is OK if the display turns on.)

<Indoor unit address>

- 5** Push the TEMP.  /  buttons repeatedly to set the CODE No. to **13**.
- 6** Push the TIME  /  buttons repeatedly to set an indoor unit address.
- 7** Push the  button.
(It is OK if the display turns on.)

<Group address>

- 8** Push the TEMP.  /  buttons repeatedly to set the CODE No. to **14**.
- 9** Push the TIME  /  buttons repeatedly to set a group address. If the indoor unit is individual, set the address to **0000** ; header unit, **0001** ; follower unit, **0002** .
Individual : 0000
Header unit : 0001
Follower unit : 0002 } In case of group control
- 10** Push the  button.
(It is OK if the display turns on.)
- 11** Push the  button.
The address setting is complete.
(**SETTING** flashes. You can control the unit after **SETTING** has disappeared.)

NOTE

- 1. Do not use address numbers 29 or 30 when setting system addresses using the remote controller. These 2 address numbers cannot be used on outdoor units and the CODE No. [E04] (Indoor / outdoor communication error) will appear if they are mistakenly used.**
- 2. If you set addresses to indoor units in 2 or more refrigerate lines manually using the remote controller and will control them centrally, set the header outdoor unit of each line as below.**
 - Set a system address for the header outdoor unit of each line with SW13 and 14 of their interface P.C. boards.
 - Turn off dip switch 2 of SW30 on the interface P.C. boards of all the header outdoor units connected to the same central control, except the unit that has the lowest address. (For unifying the termination of the wiring for the central control of indoor and outdoor units)
 - Connect the relay connectors between the [U1, U2] and [U3, U4] terminals on the header outdoor unit of each refrigerate line.
 - After finishing all the settings above, set the address of the central control devices. (For the setting of the central control address, refer to the installation manuals of the central control devices.)

Confirming the indoor unit addresses and the position of an indoor unit using the remote controller

◆ Confirming the numbers and positions of indoor units

To see the indoor unit address of an indoor unit which you know the position of

- ▼ When the unit is individual (the indoor unit is paired with a wired remote controller one-to-one), or it is a group-controlled one.

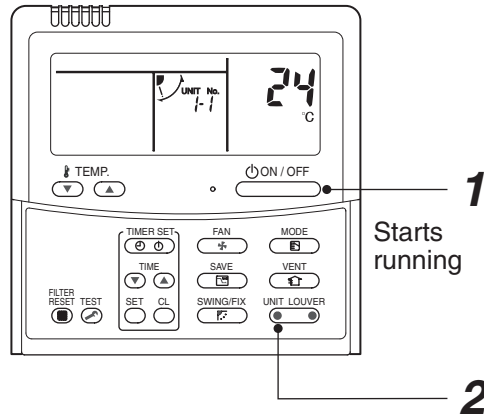

(Execute it while the units are running.)

1 Push the  button if the units stop.

2 Push the  button (left side of the button).

A unit numbers  is indicated on the LCD (it will disappear after a few seconds). The indicated number shows the system address and indoor unit address of the unit.

When 2 or more indoor units are connected to the remote controller (group-controlled units), a number of other connected units appears each time you push the  button (left side of the button).



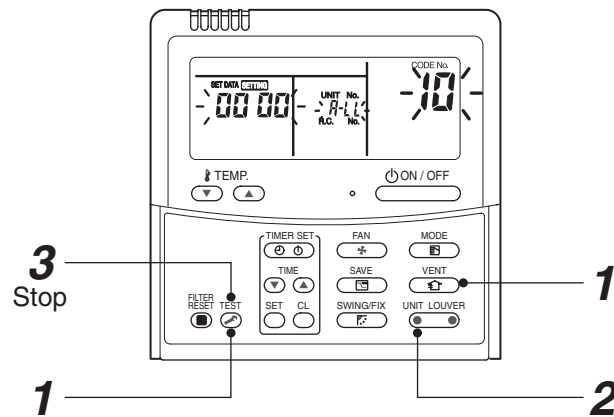

To find an indoor unit's position from its address

▼ When checking unit numbers controlled as a group



(Execute it while the units are stopped.)

The indoor unit numbers in a group are indicated one after another. The fan and louvers of the indicated units are activated.

- 1 Push and hold the  and  buttons at the same time for more than 4 seconds.**
 - **ALL** appears on UNIT No. on the LCD display.
 - The fans and louvers of all the indoor units in the group are activated.
- 2 Push the  button (left side of the button). Each time you push the button, the indoor unit numbers are indicated one after another.**
 - The first-indicated unit number is the address of the header unit.
 - Only the fan and louvers of the indicated indoor unit are activated.
- 3 Push the  button to finish the procedure.**

All the indoor units in the group stop.

- ▼ To check all the indoor unit addresses using an arbitrary wired remote controller.
(When communication wirings of 2 or more refrigerant lines are interconnected for central control)

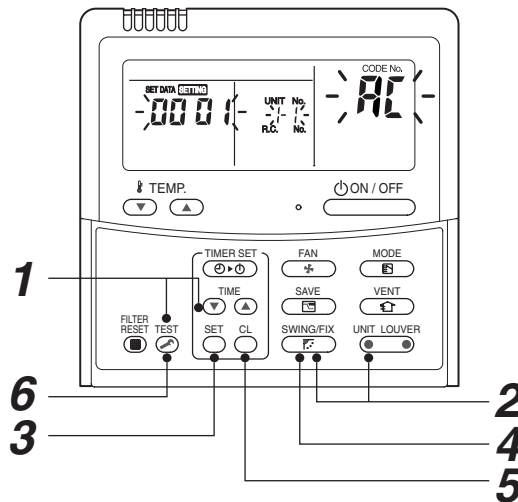

(Execute it while the units are stopped.)

You can check indoor unit addresses and positions of the indoor units in a single refrigerant line. When an outdoor unit is selected, the indoor unit numbers of the refrigerant line of the selected unit are indicated one after another and the fan and louvers of the indicated indoor units are activated.

- 1** Push and hold the TIME and buttons at the same time for more than 4 seconds. At first, the line 1 and CODE No. (Address Change) are indicated on the LCD display. (Select an outdoor unit.)
 - 2** Push the button (left side of the button) and buttons repeatedly to select a system address.
 - 3** Push the button to confirm the system address selection.
 - The address of an indoor unit connected to the selected refrigerant line is indicated on the LCD display and its fan and louvers are activated.
 - 4** Push the button (left side of the button). Each time you push the button, the indoor unit numbers of the selected refrigerant line are indicated one after another.
 - Only the fan and louvers of the indicated indoor unit are activated.
- ◆ To select another system address
- 5** Push the button to return to step 2.
 - After returning to step 2, select another system address and check the indoor unit addresses of the line.
 - 6** Push the button to finish the procedure.







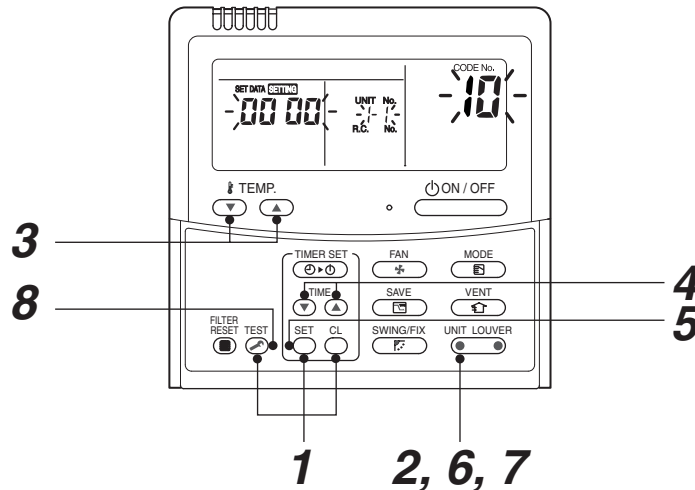





◆ Changing the indoor unit address using a remote controller

To change an indoor unit address using a wired remote controller.

- ▼ The method to change the address of an individual indoor unit (the indoor unit is paired with a wired remote controller one-to-one), or an indoor unit in a group. (The method is available when the addresses have already been set automatically.)



(Execute it while the units are stopped.)

- 1** Push and hold the , , and  buttons at the same time for more than 4 seconds. (If 2 or more indoor units are controlled in a group, the first indicated UNIT No. is that of the head unit.)
- 2** Push the  button (left side of the button) repeatedly to select an indoor unit number to change if 2 or more units are controlled in a group. (The fan and louvers of the selected indoor unit are activated.) (The fan of the selected indoor unit is turned on.)
- 3** Push the TEMP.  /  buttons repeatedly to select  for CODE No.
- 4** Push the TIME  /  buttons repeatedly to change the value indicated in the SET DATA section to that you want.
- 5** Push the  button.
- 6** Push the  button (left side of the button) repeatedly to select another indoor UNIT No. to change. Repeat steps **4** to **6** to change the indoor unit addresses so as to make each of them unique.
- 7** Push the  button (left side of the button) to check the changed addresses.
- 8** If the addresses have been changed correctly, push the  button to finish the procedure.

- ▼ To change all the indoor unit addresses using an arbitrary wired remote controller. (The method is available when the addresses have already been set automatically.)

(When communication wirings of 2 or more refrigerant lines are interconnected for central control)

NOTE

You can change the addresses of indoor units in each refrigerant line using an arbitrary wired remote controller.

- * Enter the address check / change mode and change the addresses.

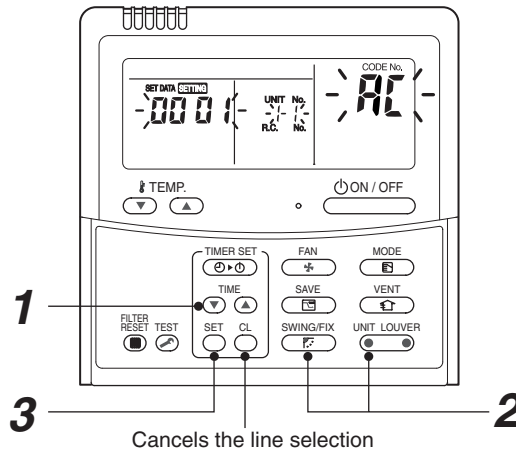

3 Cancels the line selection

If no number appears on UNIT No., no outdoor unit exists on the line. Push button and select another line following step 2.

(Execute it while the units are stopped.)

- 1 Push and hold the TIME (▼) / (▲) buttons at the same time for more than 4 seconds. At first, the line 1 and CODE No. AC (Address Change) are indicated on the LCD display.
- 2 Push the UNIT LOUVER button (left side of the button) and the SWING/FIX buttons repeatedly to select a system address.
- 3 Push the SET button.
 - The address of one of the indoor units connected to the selected refrigerant line is indicated on the LCD display and the fan and louvers of the unit are activated. At first, the current indoor unit address is displayed in SET DATA. (No system address is indicated.)

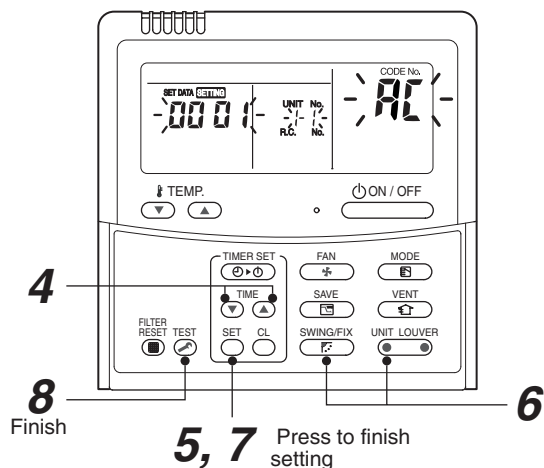

- 4** Push the **TIME** (▼) / (▲) buttons repeatedly to change the value of the indoor unit address in **SET DATA**.
Change the value in **SET DATA** to that of a new address.
- 5** Push the **SET** button to confirm the new address on **SET DATA**.
- 6** Push the **UNIT LOUVER** button (left side of the button) repeatedly to select another address to change.
Each time you push the button, the indoor unit numbers in a refrigerant line are indicated one after another. Only the fan and louvers of the selected indoor unit are activated.
Repeat steps **4** to **6** to change the indoor unit addresses so as to make each of them unique.
- 7** Push the **SET** button.
(All the segments on the LCD display light up.)
- 8** Push the **TEST** button to finish the procedure.

◆ Error clearing function

How to clear the error using the wired remote controller

▼ Clearing an error of the outdoor unit

Clear the currently detected outdoor unit for each refrigerant line to which the indoor unit controlled by the remote controller is connected. (The indoor unit error is not cleared.)
Use the service monitoring function of the remote controller.

- 1 Push and hold the CL , and TEST for 4 seconds or longer to enter the service monitoring mode.
- 2 Push the TEMP. button to set CODE No. to "FF".
- 3 The display in A of the following figure counts down as follows at 5-second intervals:
"0005" → "0004" → "0003" → "0002" → "0001" → "0000".
The error is cleared when "0000" appears.
However, the display counts down from "0005" again.
- 4 Push the TEST to return the display to normal.

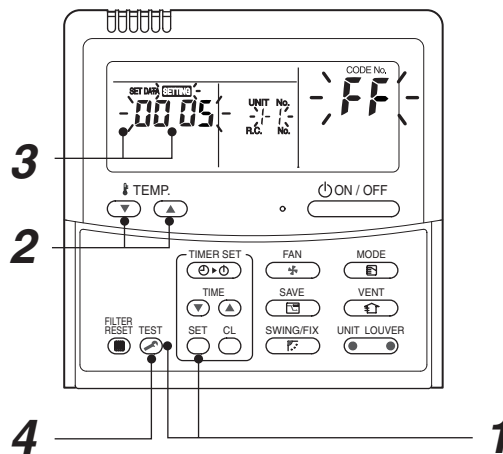

▼ Clearing an error of the indoor unit

Push the ON / OFF button on the remote controller.
(Only the error of the indoor unit controlled by the remote controller will be cleared.)



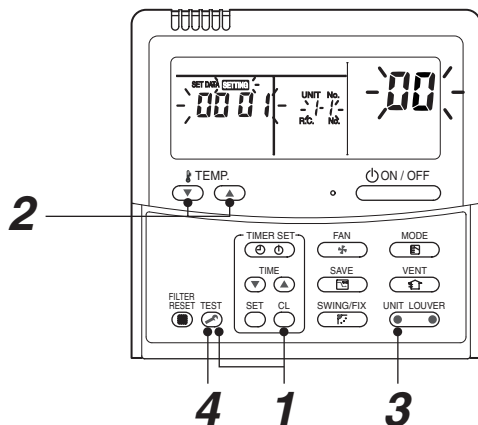

Monitoring function of wired remote controller

The following monitoring function is available if the remote controller of RBC-ATM32E is used.



▼ Content

Enter the service monitoring mode using the remote controller to check the sensor temperature or operation status of the remote controller, indoor unit, and outdoor unit.

- 1** Push and hold the , and  for 4 seconds or longer to enter the service monitoring mode.
The service monitor lights up. The temperature of CODE No. **00** appears at first.
- 2** Push the  button to change to CODE No. of the item to monitor. Refer to the following table for CODE No.
- 3** Push the left part of the  button (left side of the button) to change to the item to monitor. Monitor the sensor temperature or operation status of the indoor unit and outdoor unit in the refrigerant line
- 4** Push the  to return the display to normal.

◆ Target outdoor unit (SMMS, SHRM, Mini-SMMS – Series 1 – 2)

	CODE No.	Data	Format	Unit	Remote controller display example
Indoor unit data	00	Room temperature (in control) *1	×1	°C	[0024]=24 °C
	01	Room temperature (Remote controller)	×1	°C	
	02	Air Temperature (TA)	×1	°C	
	03	Coil Temperature (TCJ)	×1	°C	
	04	Coil Temperature (TC2)	×1	°C	
	05	Coil Temperature (TC1)	×1	°C	
	08	PMV	×1	pls	[0050]=500 pls
System unit data	0A	Number of connected indoor units	×1	—	[0048]=48
	0B	Total horse power of connected indoor units	×1	HP	[0415]=41.5 HP
	0C	Number of connected outdoor units	×1	—	[0004]=4
	0D	Total horse power of outdoor units	×1	HP	[0420]=42 HP

	CODE No.				Data	Format	Unit	Remote controller display example
	U1	U2	U3	U4				
Individual data 1 of outdoor unit *3	10	20	30	40	Discharge temperature of compressor 1 (Td1)	×1	°C	[0024]=24 °C
	11	21	31	41	Discharge temperature of compressor 2 (Td2)	×1	°C	
	12	22	32	42	Detection pressure of high-pressure sensor (Pd)	×1	MPa	[0123]=1.23 MPa
	13	23	33	43	Detection pressure of low-pressure sensor (Ps)	×1	MPa	
	14	24	34	44	Suction Temperature (TS)	×1	°C	[0024]=24 °C
	15	25	35	45	Coil Temperature 1 (TE)	×1	°C	
	16	26	36	46	Liquid Temperature (TL)	×1	°C	
	17	27	37	47	Outdoor Temperature (TO)	×1	°C	
	18	28	38	48	Low-pressure saturation temperature (TU)	×1	°C	
	19	29	39	49	Current of compressor 1 (I1)	×1	A	[0135]=13.5 A
	1A	2A	3A	4A	Current of compressor 2 (I2)	×1	A	
	1B	2B	3B	4B	PMV1 + 2	×1	pls	[0050]=500 pls
	1C	2C	3C	4C	PMV3	×1	pls	[0050]=500 pls
	1D	2D	3D	4D	Compressor 1, 2 ON/OFF	*2	—	
	1E	2E	3E	4E	Outdoor fan mode	×1	—	[0031]=Mode 31
	1F	2F	3F	4F	Horse power of outdoor unit	×1	HP	[0016]=16HP

*1 In the case of group connection, only the header indoor unit data can be displayed.

*2 01 ... Only compressor 1 is on

10 ... Only compressor 2 is on

11 ... Both compressor 1 and 2 are on

*3 The upper digit of CODE No. indicates the outdoor unit No.

U1 outdoor unit (Header unit)

U2 outdoor unit (follower unit 1)

U3 outdoor unit (follower unit 2)

U4 outdoor unit (follower unit 3)

◆ Target outdoor unit (SMMS-i – Series 4)

	CODE No.	Data	Format	Unit	Remote controller display example
Indoor unit data *2	00	Room temperature (in control)	×1	°C	[0024]=24 °C
	01	Room temperature (Remote controller)	×1	°C	
	02	Air Temperature (TA)	×1	°C	
	03	Coil Temperature (TCJ)	×1	°C	
	04	Coil Temperature (TC2)	×1	°C	
	05	Coil Temperature (TC1)	×1	°C	
	06	Discharge temperature (TF) *1	×1	°C	
	08	PMV	×1/10	pls	[0150]=1500 pls
	09	Air Suction Temperature of direct expansion coil (TSA) *1	×1	°C	[0024]=24 °C
	FA	Outdoor Air Temperature (TOA) *1	×1	°C	
System unit data	0A	Number of connected indoor units	×1	—	[0048]=48
	0B	Total horse power of connected indoor units	×10	HP	[0415]=41.5HP
	0C	Number of connected outdoor units	×1	—	[0004]=4
	0D	Total horse power of outdoor units	×10	HP	[0420]=42HP

	CODE No.				Data	Format	Unit	Remote controller display example
	U1	U2	U3	U4				
Individual data 1 of outdoor unit *3	10	20	30	40	Detection pressure of high-pressure sensor (Pd)	×100	MPa	[0123]=1.23 MPa
	11	21	31	41	Detection pressure of low-pressure sensor (Ps)	×100	MPa	
	12	22	32	42	Discharge temperature of compressor 1 (Td1)	×1	°C	[0024]=24 °C
	13	23	33	43	Discharge temperature of compressor 2 (Td2)	×1	°C	
	14	24	34	—	Discharge temperature of compressor 3 (Td3)	×1	°C	
	15	25	35	45	Suction Temperature (TS)	×1	°C	
	16	26	36	46	Coil Temperature 1 (TE1)	×1	°C	
	17	27	37	—	Coil Temperature 2 (TE2)	×1	°C	
	18	28	38	48	Liquid Temperature (TL)	×1	°C	
	19	29	39	49	Outdoor Temperature (TO)	×1	°C	
	1A	2A	3A	4A	PMV1 + 2	×1	pls	[0050]=500 pls
	1B	2B	3B	—	PMV4	×1	pls	
	1C	2C	3C	4C	Current of compressor 1 (I1)	×10	A	[0135]=13.5 A
	1D	2D	3D	4D	Current of compressor 2 (I2)	×10	A	
	1E	2E	3E	—	Current of compressor 3 (I3)	×10	A	
	1F	2F	3F	4F	Outdoor fan current (IFan)	×10	A	

- *1 The TF/TSA/TOA sensors are equipped only with some types of indoor units. The data does not appear for other types.
- *2 In the case of group connection, only the header indoor unit data can be displayed.
- *3 The upper digit of CODE No. indicates the outdoor unit No.
- *4 [(The upper digit of CODE No.) – 4] indicates the outdoor unit No.
 1*, 5* ... U1 outdoor unit (Header unit)
 2*, 6* ... U2 outdoor unit (follower unit 1)
 3*, 7* ... U3 outdoor unit (follower unit 2)
 4*, 8* ... U4 outdoor unit (follower unit 3)
- *5 Only CODE No. 5• of U1 outdoor unit (Header unit) is displayed.

	CODE No.				Data	Format	Unit	Remote controller display example
	U1	U2	U3	U4				
Individual data 2 of outdoor unit *4	50	60	70	80	Rotation of compressor 1	×10	rps	[0642]=64.2 rps
	51	61	71	81	Rotation of compressor 2	×10	rps	
	52	62	72	—	Rotation of compressor 3	×10	rps	
	53	63	73	83	Outdoor fan mode	×1	Mode	[0058]=Mode 58
	54	64	74	84	Heat sink temperature of compressor IPDU1	×1	°C	[0024]=24 °C
	55	65	75	85	Heat sink temperature of compressor IPDU2	×1	°C	
	56	66	76	—	Heat sink temperature of compressor IPDU3	×1	°C	
	57	67	77	87	Heat sink temperature of outdoor fan IPDU	×1	°C	
	58	—	—	—	In heat/cool collecting control *5	0: Normal 1: In collecting control		[0010] = In heat collecting control [0001] = In cool collecting control
	59	—	—	—	Pressure release *5	0: Normal 1: In release control		[0010] = In pressure release control
	5A	—	—	—	Discharge temperature release *5			[0001] = In discharge temperature release control
	5B	—	—	—	Terminal unit release (U2 / U3 / U4 outdoor unit) *5			[0100] = In U2 outdoor unit release control [0010] = In U3 outdoor unit release control [0001] = In U4 outdoor unit release control
	5F	6F	7F	8F	Horse power of outdoor unit	×1	HP	[0016]=16HP

- *1 The TF / TSA / TOA sensors are equipped only with some types of indoor units. The data does not appear for other types.
- *2 In the case of group connection, only the header indoor unit data can be displayed.
- *3 The upper digit of CODE No. indicates the outdoor unit No.
- *4 [(The upper digit of CODE No.) – 4] indicates the outdoor unit No.
 1*, 5* ... U1 outdoor unit (Center unit)
 2*, 6* ... U2 outdoor unit (terminal unit 1)
 3*, 7* ... U3 outdoor unit (terminal unit 2)
 4*, 8* ... U4 outdoor unit (terminal unit 3)
- *5 Only CODE No. 5* of U1 outdoor unit (Center unit) is displayed.

◆ LED display of circuit board

1. D501 (Red)

- Lights up when the power is turned on (Microcomputer works)
- Blinks at 1-second intervals (0.5-second): No EEPROM, or writing error
- Blinks at 10-second intervals (5-second): No DISP mode
- Blinks at 2-second intervals (1-second): Function change being set (EEPROM)

2. D403 (Red)

- Lights up (on hardware) when the power is supplied to the remote controller

9. TROUBLESHOOTING

9-1. Overview

(1) Before engaging in troubleshooting

(a) Applicable models

All Super Module Multi (SMMS, SHRM, Mini-SMMS, SMMS-i) models.

(Indoor units: MMO-APOOO, Outdoor units: MMY-MAPOOOO*, MCY-MAPOOOHT*)

(b) Tools and measuring devices required

- Screwdrivers (Philips, flat head), spanners, long-nose pliers, nipper, pin to push reset switch, etc.
- Multimeter, thermometer, pressure gauge, etc.

(c) Things to check prior to troubleshooting (behaviors listed below are normal)

NO.	Behavior	Possible cause
1	A compressor would not start	<ul style="list-style-type: none"> • Could it just be the 3-minute delay period (3 minutes after compressor shutdown)? • Could it just be the air conditioner having gone thermo OFF? • Could it just be the air conditioner operating in fan mode or put on the timer? • Could it just be the system going through initial communication?
2	An indoor fan would not start	<ul style="list-style-type: none"> • Could it just be cold air discharge prevention control, which is part of heating?
3	An outdoor fan would not start or would change speed for no reason	<ul style="list-style-type: none"> • Could it just be cooling operation under low outside temperature conditions? • Could it just be defrosting operation?
4	An indoor fan would not stop	<ul style="list-style-type: none"> • Could it just be the elimination of residual heat being performed as part of the air conditioner shutdown process after heating operation?
5	The air conditioner would not respond to a start / stop command from a remote controller	<ul style="list-style-type: none"> • Could it just be the air conditioner operation under external or remote controller?

(2) Troubleshooting procedure

When a fault occurs, proceed with troubleshooting in accordance with the procedure shown below.

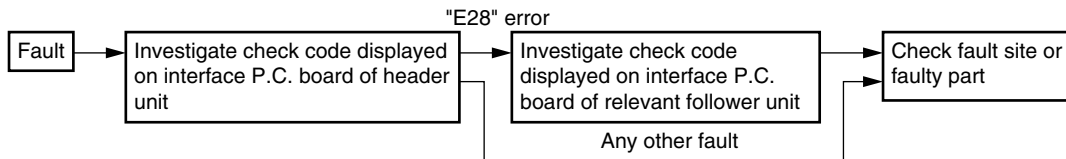

NOTE

Rather than a genuine fault (see the List of Check Codes below), the problem could have been caused by a microprocessor malfunction attributable to a poor quality of the power source or an external noise. Check for possible noise sources, and shield the remote controller wiring and signal wires as necessary.

9-2. Troubleshooting method

The remote controllers (main remote controller and central control remote controller) and the interface P.C. board of an outdoor unit are provided with an LCD display (remote controller) or a 7-segment display (outdoor interface P.C. board) to display operational status. Using this self-diagnosis feature, the fault site / faulty part may be identified in the event of a fault by following the method described below.

The list below summarizes check codes detected by various devices. Analyze the check code according to where it is displayed and work out the nature of the fault in consultation with the list.

- When investigating a fault on the basis of a display provided on the indoor remote controller or TCC-LINK central control remote controller - See the “TCC-LINK remote controller or main remote controller display” section of the list.
- When investigating a fault on the basis of a display provided on an outdoor unit - See the “Outdoor 7-segment display” section of the list.
- When investigating a fault on the basis of a wireless remote controller-controlled indoor unit - See the “Light sensor indicator light block” section of the list.

List of check codes (indoor unit)

(Error detected by indoor unit)

IPDU: Intelligent Power Drive Unit (Inverter P.C. board)

○: Lighting, ⊙: Flashing, ●: Goes off

ALT.: Flashing is alternately when there are two flashing LED

SIM: Simultaneous flashing when there are two flashing LED

Check code			Display of receiving unit				Typical fault site	Description of error
TCC-LINK central control or main remote controller display	Outdoor 7-segment display		Indicator light block					
		Sub-code	Operation ⏻	Timer ⌚	Ready ⊙	Flash		
E03	—	—	⊙	●	●		Indoor-remote controller periodic communication error	Communication from remote controller or network adaptor has been lost (so has central control communication).
E04	—	—	●	●	⊙		Indoor-outdoor periodic communication error	Signals are not being received from outdoor unit.
E08	E08	Duplicated indoor address	⊙	●	●		Duplicated indoor address	Indoor unit detects address identical to its own.
E10	—	—	⊙	●	●		Indoor inter-MCU communication error	MCU communication between main controller and motor microcontroller is faulty.
E18	—	—	⊙	●	●		Error in periodic communication between indoor header and follower unit	Periodic communication between indoor header and follower units cannot be maintained.
F01	—	—	⊙	⊙	●	ALT	Indoor heat exchanger temperature sensor (TCJ) error	Heat exchanger temperature sensor (TCJ) has been open / shortcircuited.
F02	—	—	⊙	⊙	●	ALT	Indoor heat exchanger temperature sensor (TC2) error	Heat exchanger temperature sensor (TC2) has been open / shortcircuited.
F03	—	—	⊙	⊙	●	ALT	Indoor heat exchanger temperature sensor (TC1) error	Heat exchanger temperature sensor (TC1) has been open / shortcircuited.
F10	—	—	⊙	⊙	●	ALT	Ambient temperature sensor (TA) error	Ambient temperature sensor (TA) has been open / short-circuited.
F11	—	—	⊙	⊙	●	ALT	Discharge temperature sensor (TF) error	Discharge temperature sensor (TF) has been open / shortcircuited.
F29	—	—	⊙	⊙	●	SIM	P.C. board or other indoor error	Indoor EEPROM is abnormal (some other error may be detected).
L03	—	—	⊙	●	⊙	SIM	Duplicated indoor group header unit	There is more than one header unit in group.
L07	—	—	⊙	●	⊙	SIM	Connection of group control cable to stand-alone indoor unit	There is at least one stand-alone indoor unit to which group control cable is connected.
L08	L08	—	⊙	●	⊙	SIM	Indoor group address not set	Address setting has not been performed for one or more indoor units (also detected at outdoor unit end).
L09	—	—	⊙	●	⊙	SIM	Indoor capacity not set	Capacity setting has not been performed for indoor unit.
L20	—	—	⊙	○	⊙	SIM	Duplicated central control address	There is duplication in central control address setting.
L30	L30	Detected indoor unit No.	⊙	○	⊙	SIM	Indoor external error input (interlock)	Unit shutdown has been caused by external error input (CN80).
P01	—	—	●	⊙	⊙	ALT	Indoor AC fan error	Indoor AC fan error is detected (activation of fan motor thermal relay).
P10	P10	Detected indoor unit No.	●	⊙	⊙	ALT	Indoor overflow error	Float switch has been activated.
P12	—	—	●	⊙	⊙	ALT	Indoor DC fan error	Indoor DC fan error (e.g. overcurrent or lock-up) is detected.
P31	—	—	⊙	●	⊙	ALT	Other indoor unit error	Follower unit cannot be operated due to header unit alarm (E03 / L03 / L07 / L08).

(Error detected by main remote controller)

Check code		Display of receiving unit		Typical fault site	Description of error
Main remote controller	Outdoor 7-segment display	Indicator light block			
	Sub-code	Operation ⏻	Timer Ready ⏻		
E01	—	—	⊙ ● ●	No master remote controller, faulty remote controller communication (reception)	Signals cannot be received from indoor unit; master remote controller has not been set (including two remote controller control).
E02	—	—	⊙ ● ●	Faulty remote controller communication (transmission)	Signals cannot be transmitted to indoor unit.
E02	—	—	⊙ ● ●	Duplicated master remote controller	Both remote controllers have been set as master remote controller in two remote controller control (alarm and shutdown for header unit and continued operation for follower unit)

(Error detected by central control device)

Check code		Display of receiving unit		Typical fault site	Description of error
TCC-LINK central control	Outdoor 7-segment display	Indicator light block			
	Sub-code	Operation ⏻	Timer Ready ⏻		
C05	—	—	No indication (when main remote controller also in use)	Faulty central control communication (transmission)	Central control device is unable to transmit signal due to duplication of central control device (AI-NET).
C06	—	—		Faulty central control communication (reception)	Central control device is unable to receive signal.
—	—	—		Multiple network adapters	Multiple network adapters are connected to remote controller communication line (AI-NET).
C12	—	—	—	Blanket alarm for general-purpose device control interface	Device connected to general-purpose device control interface for TCC-LINK / AI-NET is faulty.
P30	—	—	As per alarm unit (see above)	Group control follower unit error	Group follower unit is faulty (unit No. and above detail [***] displayed on main remote controller)

Note: The same error, e.g. a communication error, may result in the display of different check codes depending on the device that detects it. Moreover, check codes detected by the main remote controller / central control device do not necessarily have a direct impact on air conditioner operation.

List of check codes (outdoor unit)

(Errors detected by SMMS outdoor interface - typical examples)

IPDU: Intelligent Power Drive Unit (Inverter P.C. board)

○ :Lighting, ⊙ : Flashing, ● : Goes off

ALT.: Flashing is alternately when there are two flashing LED

SIM: Simultaneous flashing when there are two flashing LED

Check code		Display of receiving unit				Typical fault site	Description of error																																																																							
Outdoor 7-segment display		TCC-LINK central control or main remote controller display	Indicator light block																																																																											
Sub-code			Operation ⏰	Timer ⌚	Ready ⊙	Flash																																																																								
E06	Number of indoor units from which signal is received normally	E06	●	●	⊙		Dropping out of indoor unit	Indoor unit initially communicating normally fails to return signal (reduction in number of indoor units connected).																																																																						
E07	—	(E04)	●	●	⊙		Indoor-outdoor communication circuit error	Signal cannot be transmitted to indoor units (→ indoor units left without communication from outdoor unit).																																																																						
E08	Duplicated indoor address	(E08)	⊙	●	●		Duplicated indoor address	More than one indoor unit is assigned same address (also detected at indoor unit end).																																																																						
E12	01: Indoor-outdoor communication 02: Outdoor-outdoor communication	E12	⊙	●	●		Automatic address starting error	<ul style="list-style-type: none"> Indoor automatic address setting is started while automatic address setting for equipment in other refrigerant line is in progress. Outdoor automatic address setting is started while automatic address setting for indoor units is in progress. 																																																																						
E15	—	E15	●	●	⊙		Indoor unit not found during automatic address setting	Indoor unit fails to communicate while automatic address setting for indoor units is in progress.																																																																						
E16	00: Overloading 01: Number of units connected	E16	●	●	⊙		Too many indoor units connected / overloading	Combined capacity of indoor units is too large (more than 135 % of combined capacity of outdoor units).																																																																						
E19	00: No header unit 02: Two or more header units	E19	●	●	⊙		Error in number of outdoor header units	There is no or more than one outdoor header unit in one refrigerant line.																																																																						
E20	01: Connection of outdoor unit from other refrigerant line 02: Connection of indoor unit from other refrigerant line	E20	●	●	⊙		Connection to other refrigerant line found during automatic address setting	Indoor unit from other refrigerant line is detected while indoor automatic address setting is in progress.																																																																						
E23	—	E23	●	●	⊙		Outdoor-outdoor communication transmission error	Signal cannot be transmitted to other outdoor units.																																																																						
E25	—	E25	●	●	⊙		Duplicated follower outdoor address	There is duplication in outdoor addresses set manually.																																																																						
E26	Address of outdoor unit from which signal is not received normally	E26	●	●	⊙		Dropping out of outdoor unit	Follower outdoor unit initially communicating normally fails to do so (reduction in number of follower outdoor units connected).																																																																						
E28	Detected outdoor unit No.	E28	●	●	⊙		Outdoor follower unit error	Outdoor header unit detects fault relating to follower outdoor unit (detail displayed on follower outdoor unit).																																																																						
E31	<table border="1"> <thead> <tr> <th></th> <th>A3-IPDU 1</th> <th>Fan 2</th> <th>IPDU 3</th> <th>A3-IPDU 1</th> <th>Fan 2</th> <th>IPDU 3</th> </tr> </thead> <tbody> <tr> <td>01</td> <td>○</td> <td></td> <td></td> <td>0A</td> <td>○</td> <td>○</td> </tr> <tr> <td>02</td> <td>○</td> <td></td> <td></td> <td>0B</td> <td>○</td> <td>○</td> </tr> <tr> <td>03</td> <td>○</td> <td>○</td> <td></td> <td>0C</td> <td></td> <td>○</td> </tr> <tr> <td>04</td> <td></td> <td>○</td> <td></td> <td>0D</td> <td>○</td> <td>○</td> </tr> <tr> <td>05</td> <td>○</td> <td>○</td> <td></td> <td>0E</td> <td>○</td> <td>○</td> </tr> <tr> <td>06</td> <td>○</td> <td>○</td> <td></td> <td>0F</td> <td>○</td> <td>○</td> </tr> <tr> <td>07</td> <td>○</td> <td>○</td> <td>○</td> <td colspan="3">Circle (O): Faulty IPDU</td> </tr> <tr> <td>08</td> <td></td> <td></td> <td>○</td> <td></td> <td></td> <td></td> </tr> <tr> <td>09</td> <td>○</td> <td></td> <td>○</td> <td></td> <td></td> <td></td> </tr> </tbody> </table>		A3-IPDU 1	Fan 2	IPDU 3	A3-IPDU 1	Fan 2	IPDU 3	01	○			0A	○	○	02	○			0B	○	○	03	○	○		0C		○	04		○		0D	○	○	05	○	○		0E	○	○	06	○	○		0F	○	○	07	○	○	○	Circle (O): Faulty IPDU			08			○				09	○		○				E31	●	●	⊙		IPDU communication error	There is no communication between IPDUs (P.C. boards) in inverter box.
	A3-IPDU 1	Fan 2	IPDU 3	A3-IPDU 1	Fan 2	IPDU 3																																																																								
01	○			0A	○	○																																																																								
02	○			0B	○	○																																																																								
03	○	○		0C		○																																																																								
04		○		0D	○	○																																																																								
05	○	○		0E	○	○																																																																								
06	○	○		0F	○	○																																																																								
07	○	○	○	Circle (O): Faulty IPDU																																																																										
08			○																																																																											
09	○		○																																																																											
F04	—	F04	⊙	⊙	○	ALT	Outdoor discharge temperature sensor (TD1) error	Outdoor discharge temperature sensor (TD1) has been open / short-circuited.																																																																						
F05	—	F05	⊙	⊙	○	ALT	Outdoor discharge temperature sensor (TD2) error	Outdoor discharge temperature sensor (TD2) has been open / short-circuited.																																																																						
F06	01: TE1 02: TE2	F06	⊙	⊙	○	ALT	Outdoor heat exchanger temperature sensor (TE1, TE2) error	Outdoor heat exchanger temperature sensors (TE1, TE2) have been open / short-circuited.																																																																						
F07	—	F07	⊙	⊙	○	ALT	Outdoor liquid temperature sensor (TL) error	Outdoor liquid temperature sensor (TL) has been open / short-circuited.																																																																						
F08	—	F08	⊙	⊙	○	ALT	Outdoor outside air temperature sensor (TO) error	Outdoor outside air temperature sensor (TO) has been open / short-circuited.																																																																						
F11	—	F11																																																																												

Check code		Display of receiving unit				Typical fault site	Description of error	
Outdoor 7-segment display		TCC-LINK central control or main remote controller display	Indicator light block					
Sub-code			Operation 	Timer 	Ready 	Flash		
F12	–	F12				ALT	Outdoor suction temperature sensor (TS1) error	Outdoor suction temperature sensor (TS1) has been open / short-circuited.
F13	01: Compressor 1 02: Compressor 2 03: Compressor 3	F13				ALT	Outdoor IGBT built-in temperature sensor (TH) error	Open-circuit or short-circuit of the outdoor IGBT built-in temperature sensor (TH) was detected.
F15	–	F15				ALT	Outdoor temperature sensor (TE1, TL) wiring error	Wiring error in outdoor temperature sensors (TE1, TL) has been detected.
F16	–	F16				ALT	Outdoor pressure sensor (Pd, Ps) wiring error	Wiring error in outdoor pressure sensors (Pd, Ps) has been detected.
F22	–	F22				ALT	Outdoor discharge temperature sensor (TD3) error	Outdoor discharge temperature sensor (TD3) has been open / short-circuited.
F23	–	F23				ALT	Low pressure sensor (Ps) error	Output voltage of low pressure sensor (Ps) is zero.
F24	–	F24				ALT	High pressure sensor (Pd) error	Output voltage of high pressure sensor (Pd) is zero or provides abnormal readings when compressors have been turned off.
F31	–	F31				SIM	Outdoor EEPROM error	Outdoor EEPROM is faulty (alarm and shutdown for header unit and continued operation for follower unit)
H01	01: Compressor 1 02: Compressor 2 03: Compressor 3	H01					Compressor breakdown	Overcurrent of the inverter current (Idc) detection circuit was detected.
H02	01: Compressor 1 02: Compressor 2 03: Compressor 3	H02					Compressor error (Lock)	Compressor lock was detected.
H03	01: Compressor 1 02: Compressor 2 03: Compressor 3	H03					Current detection circuit error	Current error was detected while the compressor was stopped.
H04		H05					Compressor 1 case thermo activation	Compressor 1 case thermo was activated for protection.
H05	–	H05					Outdoor discharge temperature sensor (TD1) wiring error	Wiring / installation error or detachment of outdoor discharge temperature sensor (TD1) has been detected.
H06	–	H06					Activation of low-pressure protection	Low pressure (Ps) sensor detects abnormally low operating pressure.
H07	–	H07					Activation of low-pressure protection	Temperature sensor for oil level detection (TK1-5) detects abnormally low oil level.
H08	01: TK1 sensor error 02: TK2 sensor error 03: TK3 sensor error 04: TK4 sensor error 05: TK5 sensor error	H08					Error in temperature sensor for oil level detection (TK1-5)	Temperature sensor for oil level detection (TK1-5) has been open / short-circuited.
H14	–	H14					Compressor 2 case thermo activation	Compressor 2 case thermo was activated for protection.
H15	–	H15					Outdoor discharge temperature sensor (TD2) wiring error	Wiring / installation error or detachment of outdoor discharge temperature sensor (TD2) has been detected.
H16	01: TK1 oil circuit error 02: TK2 oil circuit error 03: TK3 oil circuit error 04: TK4 oil circuit error 05: TK5 oil circuit error	H16					Oil level detection circuit error	No temperature change is detected by temperature sensor for oil level detection (TK1-5) despite compressor having been started.
H25	–	H25					Outdoor discharge temperature sensor (TD3) wiring error	Wiring / installation error or detachment of outdoor discharge temperature sensor (TD3) has been detected.
L04	–	L04				SIM	Duplicated outdoor refrigerant line address	Identical refrigerant line address has been assigned to outdoor units belonging to different refrigerant piping systems.
L06	Number of priority indoor units (check code L05 or L06 depending on individual unit)	L05				SIM	Duplicated priority indoor unit (as displayed on priority indoor unit)	More than one indoor unit has been set up as priority indoor unit.
		L06				SIM	Duplicated priority indoor unit (as displayed on indoor unit other than priority indoor unit)	More than one indoor unit has been set up as priority indoor unit.

Check code			Display of receiving unit				Typical fault site	Description of error																																																																																															
Outdoor 7-segment display		TCC-LINK central control or main remote controller display	Indicator light block																																																																																																				
Sub-code				Operation	Timer	Ready	Flash																																																																																																
		⊙		●	⊙	⊙																																																																																																	
L08	—	(L08)	⊙	●	⊙	SIM	SIM Indoor group address not set	Address setting has not been performed for one or more indoor units (also detected at indoor end).																																																																																															
L10	—	L10	⊙	○	⊙	SIM	Outdoor capacity not set	Outdoor unit capacity has not been set (after P.C. board replacement).																																																																																															
L17	—	L17	⊙	○	⊙	SIM	Outdoor model incompatibility error	Old model outdoor unit (prior to 3 series) has been connected.																																																																																															
L18	—	L18	⊙	○	⊙	SIM	FS (Flow Selector) unit error	Cooling / heating cycle error resulting from piping error is detected.																																																																																															
L28		L28	⊙	○	⊙	SIM	Too many outdoor units connected	More than four outdoor units have been connected.																																																																																															
L29	SMMS (Series 1) 01: A3-IPDU1 error 02: A3-IPDU2 error 03: A3-IPDU1/A3-IPDU2 error 04: Fan IPDU error 05: A3-IPDU1 + Fan IPDU error 06: A3-IPDU2 + Fan IPDU error 07: All IPDU error SMMS-i (Series 4)	L29	⊙	○	⊙	SIM	Error in number of IPDUs	There are insufficient number of IPDUs (P.C. boards) in inverter box.																																																																																															
	<table border="1"> <thead> <tr> <th rowspan="2"></th> <th colspan="3">A3-IPDU</th> <th rowspan="2">Fan IPDU</th> <th colspan="3">A3-IPDU</th> <th rowspan="2">Fan IPDU</th> </tr> <tr> <th>1</th> <th>2</th> <th>3</th> <th>1</th> <th>2</th> <th>3</th> </tr> </thead> <tbody> <tr> <td>01</td> <td>○</td> <td></td> <td></td> <td></td> <td>0A</td> <td>○</td> <td></td> <td>○</td> </tr> <tr> <td>02</td> <td>○</td> <td></td> <td></td> <td></td> <td>0B</td> <td>○</td> <td>○</td> <td>○</td> </tr> <tr> <td>03</td> <td>○</td> <td></td> <td></td> <td></td> <td>0C</td> <td></td> <td></td> <td>○</td> </tr> <tr> <td>04</td> <td></td> <td>○</td> <td></td> <td></td> <td>0D</td> <td>○</td> <td>○</td> <td>○</td> </tr> <tr> <td>05</td> <td>○</td> <td>○</td> <td></td> <td></td> <td>0E</td> <td>○</td> <td>○</td> <td>○</td> </tr> <tr> <td>06</td> <td>○</td> <td>○</td> <td></td> <td></td> <td>0F</td> <td>○</td> <td>○</td> <td>○</td> </tr> <tr> <td>07</td> <td>○</td> <td>○</td> <td>○</td> <td></td> <td colspan="3">Circle (○): Faulty IPDU</td> <td></td> </tr> <tr> <td>08</td> <td></td> <td></td> <td>○</td> <td></td> <td colspan="3"></td> <td></td> </tr> <tr> <td>09</td> <td>○</td> <td></td> <td>○</td> <td></td> <td colspan="3"></td> <td></td> </tr> </tbody> </table>		A3-IPDU			Fan IPDU	A3-IPDU			Fan IPDU	1	2	3	1	2	3	01	○				0A	○		○	02	○				0B	○	○	○	03	○				0C			○	04		○			0D	○	○	○	05	○	○			0E	○	○	○	06	○	○			0F	○	○	○	07	○	○	○		Circle (○): Faulty IPDU				08			○						09	○		○											
	A3-IPDU			Fan IPDU	A3-IPDU			Fan IPDU																																																																																															
	1	2	3		1	2	3																																																																																																
01	○				0A	○		○																																																																																															
02	○				0B	○	○	○																																																																																															
03	○				0C			○																																																																																															
04		○			0D	○	○	○																																																																																															
05	○	○			0E	○	○	○																																																																																															
06	○	○			0F	○	○	○																																																																																															
07	○	○	○		Circle (○): Faulty IPDU																																																																																																		
08			○																																																																																																				
09	○		○																																																																																																				
L30	Detected indoor unit No.	(L30)	⊙	○	⊙	SIM	Indoor external error input (interlock)	Indoor unit has been shut down for external error input in one refrigerant line (detected by indoor unit).																																																																																															
P03	—		⊙	●	⊙	ALT	Outdoor discharge (TD1) temperature error	Outdoor discharge temperature sensor (TD1) has detected abnormally high temperature.																																																																																															
P04	P0301: Compressor 1 02: Compressor 2 03: Compressor 3	P04	⊙	●	⊙	ALT	High-pressure SW activation	High-pressure SW was activated.																																																																																															
P05	00: Open phase detected 01: Compressor 1 02: Compressor 2 03: Compressor 3	P05	⊙	●	⊙	ALT	Open phase / power failure Inverter DC voltage (Vdc) error MG-CTT error	Open phase is detected when power is turned on. Inverter DC voltage is too high (overvoltage) or too low (undervoltage).																																																																																															
P07	01: Compressor 1 02: Compressor 2 03: Compressor 3	P07	⊙	●	⊙	ALT	Heat sink overheating error	Temperature sensor built into IGBT (TH) detects overheating.																																																																																															
P10	Indoor unit No. detected	(P10)	●	⊙	⊙	ALT	Indoor unit overflow	Indoor unit has been shutdown in one refrigerant line due to detection of overflow (detected by indoor unit).																																																																																															
P13	—	P13	●	⊙	⊙	ALT	Outdoor liquid backflow detection error	State of refrigerant cycle circuit indicates liquid backflow operation.																																																																																															
P15	01: TS condition 02: TD condition	P15	⊙	●	⊙	ALT	Gas leak detection	Outdoor suction temperature sensor (TS1) detects sustained and repeated high temperatures that exceed standard value.																																																																																															
P17	—	P17	⊙	●	⊙	ALT	Outdoor discharge (TD2) temperature error	Outdoor discharge temperature sensor (TD2) detects abnormally high temperature.																																																																																															
P18	—	P18	⊙	●	⊙	ALT	Outdoor discharge (TD3) temperature error	Outdoor discharge temperature sensor (TD3) detects abnormally high temperature.																																																																																															
P19	Outdoor unit No. detected	P19	⊙	●	⊙	ALT	4-way valve reversing error	Abnormality in refrigerating cycle is detected during heating operation.																																																																																															
P20	—	P20	⊙	●	⊙	ALT	Activation of high-pressure protection	High pressure (Pd) sensor detects high pressure that exceeds standard value.																																																																																															

MG-CTT: Magnet contactor

(Errors detected by IPDU featuring in SMMS standard outdoor unit - typical examples)

Check code		Display of receiving unit		Typical fault site	Description of error
Outdoor 7-segment display	TCC-LINK central control or main remote controller display	Indicator light block			
Sub-code		Operation	Timer Ready	Flash	
F13	01: Compressor 1 02: Compressor 2 03: Compressor 3	F13	⊙ ⊙ ○	ALT	Error in temperature sensor built into indoor IGBT (TH) Temperature sensor built into indoor IGBT (TH) has been open / short-circuited.
H01	01: Compressor 1 02: Compressor 2 03: Compressor 3	H01	● ⊙ ●		Compressor breakdown Inverter current (Idc) detection circuit detects overcurrent.
H02	01: Compressor 1 02: Compressor 2 03: Compressor 3	H02	● ⊙ ●		Compressor error (lockup) Compressor lockup is detected
H03	01: Compressor 1 02: Compressor 2 03: Compressor 3	H03	● ⊙ ●		Current detection circuit error Abnormal current is detected while inverter compressor is turned off.
P04	01: Compressor 1 02: Compressor 2 03: Compressor 3	P04	⊙ ● ⊙	ALT	Activation of high-pressure SW High-pressure SW is activated.
P07		P07	⊙ ● ⊙	ALT	Heat sink overheating error Temperature sensor built into IGBT (TH) detects overheating.
P20		P20	⊙ ● ⊙	ALT	High-pressure protection activation High-pressure (Pd) sensor detected a value over the criteria.
P22	SMMS (Series 1) 04: Rotation difference error 06: Maximum rotation exceeded 08: Out of step 0A: Idc activation 0C: Fan lock 0d: Lock 0E: Sync error 0F: Control error SMMS-i (Series 4) 0..: IGBT circuit 1..: Position detection circuit error 3..: Motor lockup error 4..: Motor current detection C..: TH sensor error D..: TH sensor error E..: Inverter DC voltage error (outdoor fan) Note: Although letters 0 to F appear at locations indicated by ":", please ignore them.	P22	⊙ ● ⊙	ALT	Outdoor fan IPDU error Outdoor fan IPDU detects error.
P26	01: Compressor 1 02: Compressor 2 03: Compressor 3	P26	⊙ ● ⊙	ALT	Activation of G-Tr (IGBT) short-circuit protection Short-circuit protection for compressor motor driver circuit components is activated (momentary overcurrent).
P29	01: Compressor 1 02: Compressor 2 03: Compressor 3	P29	⊙ ● ⊙	ALT	Compressor position detection circuit error Compressor motor position detection error is detected.

Note: The above check codes are examples only, and different check codes may be displayed depending on the outdoor unit configuration (e.g. a Super heat recovery multi system). For details, see the service manual for the outdoor unit.

9-3. Troubleshooting based on information displayed on remote controller

Using main remote controller (RBC-AMT32E)

(1) Checking and testing

When a fault occurs to an air conditioner, a check code and indoor unit No. are displayed on the display window of the remote controller.

Check codes are only displayed while the air conditioner is in operation.

If the display has already disappeared, access error history by following the procedure described below.

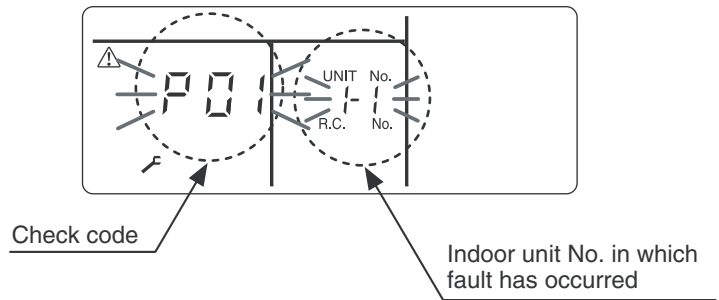

(2) Error history

The error history access procedure is described below (up to four errors stored in memory).

Error history can be accessed regardless of whether the air conditioner is in operation or shut down.

<Procedure> To be performed when system at rest

- 1 Invoke the **SERVICE CHECK** mode by pressing the **TEST** + **SET** buttons simultaneously and holding for at least 4 seconds.

The letters "SERVICE CHECK" light up, and the check code "01" is displayed, indicating the error history. This is accompanied by the indoor unit No. to which the error history is related and a check code.

- 2 To check other error history items, press the **TEMP.** button to select another check code.

Check code "01" (latest) → Check code "04" (oldest)

Note: Error history contains four items.

- 3 When the **TEST** button is pushed, normal display is restored.

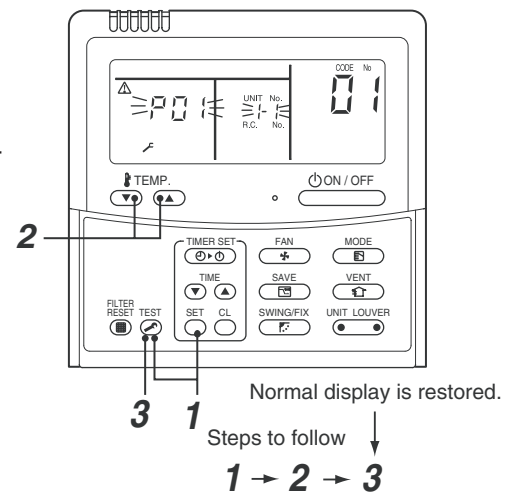

REQUIREMENT

Do not push the **CL** button as it would erase the whole error history of the indoor unit.

How to read displayed information

<7-segment display symbols>



<Corresponding alphanumerical letters>

0 1 2 3 4 5 6 7 8 9 A b C d E F H J L P

Using TCC-LINK central control remote controller (TCB-SC642TLE2)

(1) Checking and testing

When a fault occurs to an air conditioner, a check code and indoor unit No. are displayed on the display window of the remote controller. Check codes are only displayed while the air conditioner is in operation.

If the display has already disappeared, access error history by following the procedure described below.

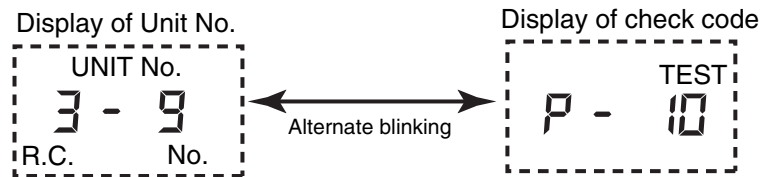

(2) Error history

The error history access procedure is described below (up to four errors stored in memory).

Error history can be accessed regardless of whether the air conditioner is in operation or shut down.

- 1** Push the + buttons simultaneously and hold for at least 4 seconds.
- 2** The letters “ SERVICE CHECK” light up, and the check code “01” is displayed.
- 3** When a group No. is selected (blinking), if there is an error history, the UNIT No. and the latest error history information are displayed alternately.

* During this procedure, the temperature setting feature is unavailable.

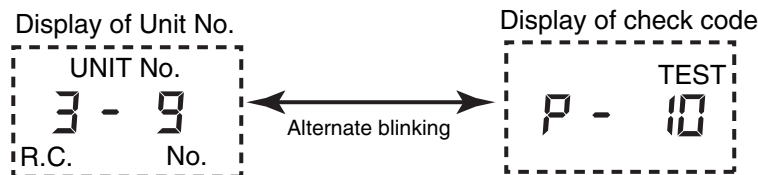

- 4** To check other error history items, push the button to select another check code (01-04.).
- 5** To check check code relating to another group, push (ZONE) and (GROUP) buttons to select a group No.
Do not push the button as it would erase the whole error history of the selected group.
- 6** To finish off the service check, push the button.



Using indoor unit indicators (receiving unit light block) (wireless type)

To identify the check code, check the 7-segment display on the header unit. To check for check codes not displayed on the 7-segment display, consult the “List of Check Codes (Indoor Unit)” in “9-2. Troubleshooting method”.

● : Goes off ○ : Lighting ☉ : Blinking (0.5 seconds)

Light block	Check code	Cause of fault		
Operation ● Timer ● Ready ● All lights out	–	Power turned off or error in wiring between receiving and indoor units		
Operation ☉ Timer ● Ready ● Blinking	E01	Faulty reception	Receiving unit	Error or poor contact in wiring between receiving and indoor units
	E02	Faulty transmission		
	E03	Loss of communication		
	E08	Duplicated indoor unit No. (address)		Setting error
	E09	Duplicated master remote controller		
	E10	Indoor unit inter-MCU communication error		
	E12	Automatic address starting error		
	E18	Error or poor contact in wiring between indoor units, indoor power turned off		
Operation ● Timer ● Ready ☉ Blinking	E04	Error or poor contact in wiring between indoor and outdoor units (loss of indoor-outdoor communication)		
	E06	Faulty reception in indoor-outdoor communication (dropping out of indoor unit)		
	E07	Faulty transmission in indoor-outdoor communication		
	E15	Indoor unit not found during automatic address setting		
	E16	Too many indoor units connected / overloading		
	E19	Error in number of outdoor header units		
	E20	Detection of refrigerant piping communication error during automatic address setting		
	E23	Faulty transmission in outdoor-outdoor communication		
	E25	Duplicated follower outdoor address		
	E26	Faulty reception in outdoor-outdoor communication, dropping out of outdoor unit		
	E28	Outdoor follower unit error		
	E31	IPDU communication error		
	Operation ● Timer ☉ Ready ☉ Alternate blinking	P01	Indoor AC fan error	
P10		Indoor overflow error		
P12		Indoor DC fan error		
P13		Outdoor liquid backflow detection error		
Operation ☉ Timer ● Ready ☉ Alternate blinking	P03	Outdoor discharge (TD1) temperature error		
	P04	Activation of outdoor high-pressure SW		
	P05	Open phase / power failure Inverter DC voltage (Vdc) error MG-CTT error		
	P07	Outdoor heat sink overheating error - Poor cooling of electrical component (IGBT) of outdoor unit		
	P15	Gas leak detection - insufficient refrigerant charging		
	P17	Outdoor discharge (TD2) temperature error		
	P18	Outdoor discharge (TD3) temperature error		
	P19	Outdoor 4-way valve reversing error		
	P20	Activation of high-pressure protection		
	P22	Outdoor fan IPDU error		
	P26	Outdoor G-Tr short-circuit error		
	P29	Compressor position detection circuit error		
	P31	Shutdown of other indoor unit in group due to fault (group follower unit error)		

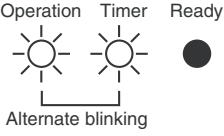
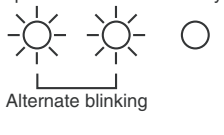
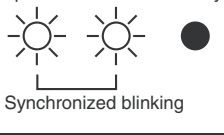
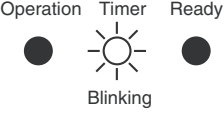
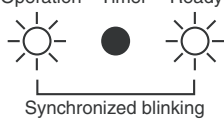
MG-CTT: Magnet contactor

Light block	Check code	Cause of fault		
Operation Timer Ready  Alternate blinking	F01	Heat exchanger temperature sensor (TCJ) error	Indoor unit temperature sensor errors	
	F02	Heat exchanger temperature sensor (TC2) error		
	F03	Heat exchanger temperature sensor (TC1) error		
	F10	Ambient temperature sensor (TA) error		
	F11	Discharge temperature sensor (TF) error		
Operation Timer Ready  Alternate blinking	F04	Discharge temperature sensor (TD1) error	Outdoor unit temperature sensor errors	
	F05	Discharge temperature sensor (TD2) error		
	F06	Heat exchanger temperature sensor (TE1, TE2) error		
	F07	Liquid temperature sensor (TL) error		
	F08	Outside air temperature sensor (TO) error		
	F12	Suction temperature sensor (TS1) error		
	F13	Heat sink sensor (TH) error		
	F15	Wiring error in heat exchanger sensor (TE1) and liquid temperature sensor (TL) Outdoor unit temperature sensor wiring / installation error		
	F16	Wiring error in outdoor high pressure sensor (Pd) and low pressure sensor (Ps) Outdoor pressure sensor wiring error		
	Operation Timer Ready  Synchronized blinking	F22	Outdoor discharge temperature sensor (TD3) error	Outdoor unit pressure sensor errors
F23		Low pressure sensor (Ps) error		
F24		High pressure sensor (Pd) error		
Operation Timer Ready  Blinking	F29	Fault in indoor EEPROM		
	H01	Compressor breakdown	Outdoor unit compressor related errors	
	H02	Compressor lockup		
	H03	Current detection circuit error		
	H05	Wiring / installation error or detachment of outdoor discharge temperature sensor (TD1)		
	H06	Abnormal drop in low-pressure sensor (Ps) reading	Protective shutdown of outdoor unit	
	H07	Abnormal drop in oil level		
	H08	Error in temperature sensor for oil level detection circuit (TK1, TK2, TK3, TK4 or TK5)		
	H15	Wiring / installation error or detachment of outdoor discharge temperature sensor (TD2)		
	H16	Oil level detection circuit error - Error in outdoor unit TK1, TK2, TK3, TK4 or TK5 circuit		
	H25	Wiring / installation error or detachment of outdoor discharge temperature sensor (TD3)		
	Operation Timer Ready  Synchronized blinking	L03	Duplicated indoor group header unit	
		L05	Duplicated priority indoor unit (as displayed on priority indoor unit)	
L06		Duplicated priority indoor unit (as displayed on indoor unit other than priority indoor unit)		
L07		Connection of group control cable to stand-alone indoor unit		
L08		Indoor group address not set		
Operation Timer Ready  Synchronized blinking	L09	Indoor capacity not set		
	L04	Duplicated outdoor refrigerant line address		
	L10	Outdoor capacity not set		
	L17	Outdoor model incompatibility error		
	L18	Flow selector units error		
	L20	Duplicated central control address		
	L28	Too many outdoor units connected		
	L29	Error in number of IPDUs		
	L30	Indoor external interlock error		

Light block	Check code	Cause of fault
<p>Operation Timer Ready</p>  <p>Synchronized blinking</p>	F31	Outdoor EEPROM error

Other (indications not involving check code)

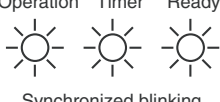
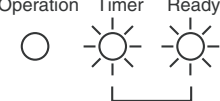
Light block	Check code	Cause of fault
<p>Operation Timer Ready</p>  <p>Synchronized blinking</p>	-	Test run in progress
<p>Operation Timer Ready</p>  <p>Alternate blinking</p>	-	Setting incompatibility (automatic cooling / heating setting for model incapable of it and heating setting for cooling-only model)

9-4. Check codes displayed on remote controller and SMMS outdoor unit (7-segment display on I/F board) and locations to be checked

For other types of outdoor units, refer to their own service manuals.

Check code			Location of detection	Description	System status	Error detection condition(s)	Check items (locations)
Main remote controller	Outdoor 7-segment display						
	Check code	Sub-code					
E01	—	—	Remote controller	Indoor-remote controller communication error (detected at remote controller end)	Stop of corresponding unit	Communication between indoor P.C. board and remote controller is disrupted.	Check remote controller inter-unit tie cable (A / B). Check for broken wire or connector bad contact. Check indoor power supply. Check for defect in indoor P.C. board. Check remote controller address settings (when two remote controllers are in use). Check remote controller P.C. board.
E02	—	—	Remote controller	Remote controller transmission error	Stop of corresponding unit	Signal cannot be transmitted from remote controller to indoor unit.	Check internal transmission circuit of remote controller. --- Replace remote controller as necessary.
E03	—	—	Indoor unit	Indoor-remote controller communication error (detected at indoor end)	Stop of corresponding unit	There is no communication from remote controller (including wireless) or network adaptor.	Check remote controller and network adaptor wiring.
E04	—	—	Indoor unit	Indoor-outdoor communication circuit error (detected at indoor end)	Stop of corresponding unit	Indoor unit is not receiving signal from outdoor unit.	Check order in which power was turned on for indoor and outdoor units. Check indoor address setting. Check indoor-outdoor tie cable. Check outdoor termination resistance setting (SW30, Bit 2).
E06	E06	No. of indoor units from which signal is received normally	I/F	Dropping out of indoor unit	All stop	Indoor unit initially communicating normally fails to return signal for specified length of time.	Check power supply to indoor unit. (Is power turned on?) Check connection of indoor-outdoor communication cable. Check connection of communication connectors on indoor P.C. board. Check connection of communication connectors on outdoor P.C. board. Check for defect in indoor P.C. board. Check for defect in outdoor P.C. board (I/F).
—	E07	—	I/F	Indoor-outdoor communication circuit error (detected at outdoor end)	All stop	Signal cannot be transmitted from outdoor to indoor units for 30 seconds continuously.	Check outdoor termination resistance setting (SW30, Bit 2). Check connection of indoor-outdoor communication circuit.

Check code			Location of detection	Description	System status	Error detection condition(s)	Check items (locations)
Main remote controller	Outdoor 7-segment display						
	Check code	Sub-code					
E08	E08	Duplicated indoor address	Indoor unit I/F	Duplicated indoor address	All stop	More than one indoor unit is assigned same address.	Check indoor addresses. Check for any change made to remote controller connection (group / individual) since indoor address setting.
E09	—	—	Remote controller	Duplicated master remote controller	Stop of corresponding unit	In two remote controller configuration (including wireless), both controllers are set up as master. (Header indoor unit is shut down with alarm, while follower indoor units continue operating.)	Check remote controller settings. Check remote controller P.C. boards.
E10	—	—	Indoor unit	Indoor inter-MCU communication error	Stop of corresponding unit	Communication cannot be established / maintained upon turning on of power or during communication.	Check for defect in indoor P.C. board
E12	E12	01: Indoor-outdoor communication 02: Outdooroutdoor communication	I/F	Automatic address starting error	All stop	Indoor automatic address setting is started while automatic address setting for equipment in other refrigerant line is in progress. Outdoor automatic address setting is started while automatic address setting for indoor units is in progress.	Perform automatic address setting again after disconnecting communication cable to that refrigerant line.
E15	E15	—	I/F	Indoor unit not found during automatic address setting	All stop	Indoor unit cannot be detected after indoor automatic address setting is started.	Check connection of indoor-outdoor communication line. Check for error in indoor power supply system. Check for noise from other devices. Check for power failure. Check for defect in indoor P.C. board.
E16	E16	00: Overloading 01-: No. of units connected	I/F	Too many indoor units connected	All stop	Combined capacity of indoor units exceeds 135 % of combined capacity of outdoor units. Note: If this code comes up after backup setting for outdoor unit failure is performed, perform "No overloading detected" setting. < "No overloading detected " setting method> Turn on SW09/Bit 2 on I/F P.C. board of outdoor header unit. More than 48 indoor units are connected.	Check capacities of indoor units connected. Check combined HP capacities of indoor units. Check HP capacity settings of outdoor units. Check No. of indoor units connected. Check for defect in outdoor P.C. board (I/F).

Check code		Location of detection	Description	System status	Error detection condition(s)	Check items (locations)	
Main remote controller	Outdoor 7-segment display						
	Check code						Sub-code
E18	—	—	Indoor unit	Error in communication between indoor header and follower units	Stop of corresponding unit	Periodic communication between indoor header and follower units cannot be maintained.	Check remote controller wiring. Check indoor power supply wiring. Check P.C. boards of indoor units.
E19	E19	00: No header unit 02: Two or more header units	I/F	Error in number of outdoor header units	All stop	There is more than one outdoor header unit in one line. There is no outdoor header unit in one line.	Outdoor header unit is outdoor unit to which indoor outdoor cable (U1,U2) is connected. Check connection of indoor-outdoor communication line. Check for defect in outdoor P.C. board (I/F).
E20	E20	01: Connection of outdoor unit from other line 02: Connection of indoor unit from other line	I/F	Connection to other line found during automatic address setting	All stop	Equipment from other line is found to have been connected when indoor automatic address setting is in progress.	Disconnect inter-line tie cable in accordance with automatic address setting method explained in gAddress setting h section.
E23	E23	—	I/F	Outdooroutdoor communication transmission error	All stop	Signal cannot be transmitted to other outdoor units for at least 30 seconds continuously.	Check power supply to outdoor units. (Is power turned on?) Check connection of tie cables between outdoor units for bad contact or broken wire. Check communication connectors on outdoor P.C. boards. Check for defect in outdoor P.C. board (I/F). Check termination resistance setting for communication between outdoor units.
E25	E25	—	I/F	Duplicated follower outdoor address	All stop	There is duplication in outdoor addresses set manually.	Note: Do not set outdoor addresses manually.
E26	E26	Address of outdoor unit from which signal is not received normally	I/F	Dropping out of outdoor unit	All stop	Outdoor unit initially communicating normally fails to return signal for specified length of time.	Backup setting is being used for outdoor units. Check power supply to outdoor unit. (Is power turned on?) Check connection of tie cables between outdoor units for bad contact or broken wire. Check communication connectors on outdoor P.C. boards. Check for defect in outdoor P.C. board (I/F).
E28	E28	Detected outdoor unit No.	I/F	Outdoor follower unit error	All stop	Outdoor header unit receives error code from outdoor follower unit.	Check check code displayed on outdoor follower unit. <Convenient functions> If SW04 is pressed and held for at least 1 second while [E28] is displayed on the 7-segmentdisplay of outdoor header unit, the fan of the outdoor unit that has been shut down due to an error comes on. If SW04 and SW05 are pressed simultaneously, the fans of normal outdoor units come on. To stop the fan or fans, press SW05 on its own.

Check code			Location of detection	Description	System status	Error detection condition(s)	Check items (locations)																																																																																			
Main remote controller	Outdoor 7-segment display																																																																																									
	Check code	Sub-code																																																																																								
E31	E31	SMMS (Series 1) 01: A3-IPDU1 error 02: A3-IPDU2 error 03: A3-IPDU1/A3-IPDU2 error 04: Fan IPDU error 05: A3-IPDU1 + Fan IPDU error 06: A3-IPDU2 + Fan IPDU error 07: All IPDU error or Communication error between IPDU and I/F circuit board or Outdoor I/F circuit board error SMMS-i (Series 4) <table border="1" style="margin-left: 20px;"> <thead> <tr> <th rowspan="2"></th> <th colspan="3">A3-IPDU</th> <th rowspan="2">Fan IPDU</th> </tr> <tr> <th>1</th> <th>2</th> <th>3</th> </tr> </thead> <tbody> <tr><td>01</td><td>○</td><td></td><td></td><td></td></tr> <tr><td>02</td><td>○</td><td></td><td></td><td></td></tr> <tr><td>03</td><td>○</td><td>○</td><td></td><td></td></tr> <tr><td>04</td><td></td><td></td><td>○</td><td></td></tr> <tr><td>05</td><td>○</td><td></td><td>○</td><td></td></tr> <tr><td>06</td><td></td><td>○</td><td>○</td><td></td></tr> <tr><td>07</td><td>○</td><td>○</td><td>○</td><td></td></tr> <tr><td>08</td><td></td><td></td><td></td><td>○</td></tr> <tr><td>09</td><td>○</td><td></td><td></td><td>○</td></tr> <tr><td>0A</td><td>○</td><td></td><td></td><td>○</td></tr> <tr><td>0B</td><td>○</td><td>○</td><td></td><td>○</td></tr> <tr><td>0C</td><td></td><td></td><td>○</td><td>○</td></tr> <tr><td>0D</td><td>○</td><td></td><td>○</td><td>○</td></tr> <tr><td>0E</td><td>○</td><td>○</td><td>○</td><td></td></tr> <tr><td>0F</td><td>○</td><td>○</td><td>○</td><td>○</td></tr> </tbody> </table> Symbol ○ signifies site of IPDU error.		A3-IPDU			Fan IPDU	1	2	3	01	○				02	○				03	○	○			04			○		05	○		○		06		○	○		07	○	○	○		08				○	09	○			○	0A	○			○	0B	○	○		○	0C			○	○	0D	○		○	○	0E	○	○	○		0F	○	○	○	○	I/F	IPDU communication error	All stop	Communication is disrupted between IPDUs (P.C. boards) in inverter box.	<ul style="list-style-type: none"> Check wiring and connectors involved in communication between IPDU-I/F P.C. board for bad contact or broken wire. Check for defect in outdoor P.C. board (I/F, A3-IPDU or Fan IPDU). Check for external noise.
	A3-IPDU			Fan IPDU																																																																																						
	1	2	3																																																																																							
01	○																																																																																									
02	○																																																																																									
03	○	○																																																																																								
04			○																																																																																							
05	○		○																																																																																							
06		○	○																																																																																							
07	○	○	○																																																																																							
08				○																																																																																						
09	○			○																																																																																						
0A	○			○																																																																																						
0B	○	○		○																																																																																						
0C			○	○																																																																																						
0D	○		○	○																																																																																						
0E	○	○	○																																																																																							
0F	○	○	○	○																																																																																						
F01	—	—	Indoor unit	Indoor TCJ sensor error	Stop of corresponding unit	Sensor resistance is infinity or zero (open / short circuit).	Check connection of TCJ sensor connector and wiring. Check resistance characteristics of TCJ sensor. Check for defect in indoor P.C. board.																																																																																			
F02	—	—	Indoor unit	Indoor TC2 sensor error	Stop of corresponding unit	Sensor resistance is infinity or zero (open / short circuit).	Check connection of TC2 sensor connector and wiring. Check resistance characteristics of TC2 sensor. Check for defect in indoor P.C. board.																																																																																			
F03	—	—	Indoor unit	Indoor TC1 sensor error	Stop of corresponding unit	Sensor resistance is infinity or zero (open / short circuit).	Check connection of TC1 sensor connector and wiring. Check resistance characteristics of TC1 sensor. Check for defect in indoor P.C. board.																																																																																			
F04	F04	—	I/F	TD1 sensor error	All stop	Sensor resistance is infinity or zero (open / short circuit).	Check connection of TD1 sensor connector. Check resistance characteristics of TD1 sensor. Check for defect in outdoor P.C. board (I/F).																																																																																			
F05	F05	—	I/F	TD2 sensor error	All stop	Sensor resistance is infinity or zero (open / short circuit).	Check connection of TD2 sensor connector. Check resistance characteristics of TD2 sensor. Check for defect in outdoor P.C. board (I/F).																																																																																			
F06	F06	TE1 sensor error 02: TE2 sensor error	I/F	TE1/TE2 sensor error	All stop	Sensor resistance is infinity or zero (open / short circuit).	Check connection of TE1/TE2 sensor connectors. Check resistance characteristics of TE1/TE2 sensors. Check for defect in outdoor P.C. board (I/F).																																																																																			

Check code			Location of detection	Description	System status	Error detection condition(s)	Check items (locations)
Main remote controller	Outdoor 7-segment display						
	Check code	Sub-code					
F07	F07	—	I/F	TL sensor error	All stop	Sensor resistance is infinity or zero (open / short circuit).	Check connection of TL sensor connector. Check resistance characteristics of TL sensor. Check for defect in outdoor P.C. board (I/F).
F08	F08	—	I/F	TO sensor error	All stop	Sensor resistance is infinity or zero (open / short circuit).	Check connection of TO sensor connector. Check resistance characteristics of TO sensor. Check for defect in outdoor P.C. board (I/F).
F10	—	—	Indoor unit	Indoor TA sensor error	Stop of corresponding unit	Sensor resistance is infinity or zero (open / short circuit).	Check connection of TA sensor connector and wiring. Check resistance characteristics of TA sensor. Check for defect in indoor P.C. board.
F11	—	—	Indoor unit	Indoor TF sensor error	Stop of corresponding unit	Sensor resistance is infinity or zero (open / short circuit).	Check connection of TF sensor connector and wiring. Check resistance characteristics of TF sensor. Check for defect in indoor P.C. board.
F12	F12	—	I/F	TS1 sensor error	All stop	Sensor resistance is infinity or zero (open / short circuit).	Check connection of TS1 sensor connector. Check resistance characteristics of TS1 sensor. Check for defect in outdoor P.C. board (I/F).
F13		01: Compressor 1 side 02: Compressor 2 side 03: Compressor 3 side	IPDU	TH sensor error	All stop	Sensor resistance is infinity or zero (open / short circuit).	Defect in IGBT built-in temperature sensor → Replace A3-IPDU P.C. board.
F15	F15	—	I/F	Outdoor temperature sensor wiring error (TE1, TL)	All stop	During compressor operation in HEAT mode, TE1 continuously provides temperature reading higher than indicated by TL by at least specified margin for 3 minutes or more.	Check installation of TE1 and TL sensors. Check resistance characteristics of TE1 and TL sensors. Check for outdoor P.C. board (I/F) error.
F16	F16	—	I/F	Outdoor pressure sensor wiring error (Pd, Ps)	All stop	Readings of high-pressure Pd sensor and lowpressure Ps sensor are switched. Output voltages of both sensors are zero.	Check connection of high-pressure Pd sensor connector. Check connection of low-pressure Ps sensor connector. Check for defect in pressure sensors Pd and Ps. Check for error in outdoor P.C. board (I/F). Check for deficiency in compressive output of compressor.
F22	F22	—	I/F	TD3 sensor error	All stop	Sensor resistance is infinity or zero. (open / short circuit)	Check connection of TD3 sensor connector. Check resistance characteristics of TD3 sensor. Check for defect in outdoor P.C. board (I/F).
F23	F23	—	I/F	Ps sensor error	All stop	Output voltage of Ps sensor is zero.	Check for connection error involving Ps sensor and Pd sensor connectors. Check connection of Ps sensor connector. Check for defect in Ps sensor. Check for deficiency in compressive output of compressor. Check for defect in 4-way valve. Check for defect in outdoor P.C. board (I/F). Check for defect in SV4 circuit.

Check code		Location of detection	Description	System status	Error detection condition(s)	Check items (locations)	
Main remote controller	Outdoor 7-segment display						
	Check code	Sub-code					
F24	F24	–	I/F	Pd sensor error	All stop	Output voltage of Pd sensor is zero (sensor open-circuited). Pd > 4.15 MPa despite compressor having been turned off.	Check connection of Pd sensor connector. Check for defect in Pd sensor. Check for defect in outdoor P.C. board (I/F).
F29	–	–	Indoor unit	Other indoor error	Stop of corresponding unit	Indoor P.C. board does not operate normally.	Check for defect in indoor P.C. board (faulty EEPROM)
F31	F31	–	I/F	Outdoor EEPROM error	All stop *1	Outdoor P.C. board (I/F) does not operate normally.	Check power supply voltage. Check power supply noise. Check for defect in outdoor P.C. board (I/F).
H01	H01	01: Compressor 1 side 02: Compressor 2 side 03: Compressor 3 side	IPDU	Compressor breakdown	All stop	Inverter current detection circuit detects overcurrent and shuts system down.	Check power supply voltage. (380-415V ± 10 %). Check for defect in compressor. Check for possible cause of abnormal overloading. Check for defect in outdoor P.C. board (A3-IPDU).
H02	H02	01: Compressor 1 side 02: Compressor 2 side 03: Compressor 3 side	IPDU	Compressor error (lockup) MG-CTT error	All stop	Overcurrent is detected several seconds after startup of inverter compressor.	Check for defect in compressor. Check power supply voltage. (380-415V ± 10 %). Check compressor system wiring, particularly for open phase. Check connection of connectors / terminals on A3-IPDU P.C. board. Check conductivity of case heater. (Check for refrigerant entrapment inside compressor.) Check for defect in outdoor P.C. board (A3-IPDU). Check outdoor MG-CTT.
H03	H03	01: Compressor 1 side 02: Compressor 2 side 03: Compressor 3 side	IPDU	Current detection circuit error	All stop	Current flow of at least specified magnitude is detected despite inverter compressor having been shut turned off.	Check current detection circuit wiring. Check defect in outdoor P.C. board (A3-IPDU).
H05	H05	–	I/F	TD1 sensor miswiring (incomplete insertion)	All stop	Discharge temperature of compressor 1 (TD1) does not increase despite compressor being in operation.	Check installation of TD1 sensor. Check connection of TD1 sensor connector and wiring. Check resistance characteristics of TD1 sensor. Check for defect in outdoor P.C. board (I/F).
H06	H06	–	I/F	Activation of low-pressure protection	All stop	Low-pressure Ps sensor detects operating pressure lower than 0.02 MPa.	Check service valves to confirm full opening (both gas and liquid sides). Check outdoor PMVs for clogging (PMV1, 2). Check for defect in SV2 or SV4 circuits. Check for defect in low-pressure Ps sensor. Check indoor filter for clogging. Check valve opening status of indoor PMV. Check refrigerant piping for clogging. Check operation of outdoor fan (during heating). Check for insufficiency in refrigerant quantity.

*1 Total shutdown in case of header unit
Continued operation in case of follower unit

MG-CTT: Magnet contactor

Check code		Location of detection	Description	System status	Error detection condition(s)	Check items (locations)	
Main remote controller	Outdoor 7-segment display						
	Check code						Sub-code
H07	H07	—	I/F	Low oil level protection	All stop	Operating compressor detects continuous state of low oil level for about 2 hours.	<p><All outdoor units in corresponding line to be checked></p> <p>Check balance pipe service valve to confirm full opening.</p> <p>Check connection and installation of TK1, TK2, TK3, TK4, and TK5 sensors.</p> <p>Check resistance characteristics of TK1, TK2, TK3, TK4, and TK5 sensors.</p> <p>Check for gas or oil leak in same line.</p> <p>Check for refrigerant entrapment inside compressor casing.</p> <p>Check SV3A, SV3B, SV3C, SV3D, SV3E, and SV3F valves for defect.</p> <p>Check oil return circuit of oil separator for clogging.</p> <p>Check oil equalizing circuit for clogging.</p>
H08	H08	01: TK1 sensor error 02: TK2 sensor error 03: TK3 sensor error 04: TK4 sensor error 05: TK5 sensor error	I/F	Error in temperature sensor for oil level detection	All stop	Sensor resistance is infinity or zero (open / short circuit).	Check connection of TK1 sensor connector. Check resistance characteristics of TK1 sensor. Check for defect in outdoor P.C. board (I/F).
					All stop	Sensor resistance is infinity or zero (open / short circuit).	Check connection of TK2 sensor connector. Check resistance characteristics of TK2 sensor. Check for defect in outdoor P.C. board (I/F).
					All stop	Sensor resistance is infinity or zero (open / short circuit).	Check connection of TK3 sensor connector. Check resistance characteristics of TK3 sensor. Check for defect in outdoor P.C. board (I/F).
					All stop	Sensor resistance is infinity or zero (open / short circuit).	Check connection of TK4 sensor connector. Check resistance characteristics of TK4 sensor. Check for defect in outdoor P.C. board (I/F).
					All stop	Sensor resistance is infinity or zero (open / short circuit).	Check connection of TK5 sensor connector. Check resistance characteristics of TK5 sensor. Check for defect in outdoor P.C. board (I/F).

Check code			Location of detection	Description	System status	Error detection condition(s)	Check items (locations)
Main remote controller	Outdoor 7-segment display						
	Check code	Sub-code					
H14	H14	—	I/F	Compressor 2 case thermo activation	All stop	Compressor 2 case thermo was activated.	<p>Check Compressor 2 case thermo circuit. (Connector, Wiring, Circuit board) Open and check the service valve. (Gas side, Liquid side) Check the outdoor PMV clogging (PMV1, 2). Check the SV42 circuit. Check the SV4 circuit (SV41 / 42 miswiring). Check the opening status of indoor PMV. Check the four-way valve error. Check the refrigerant shortage.</p>
H15	H15	—	I/F	TD2 sensor miswiring (incomplete insertion)	All stop	Air discharge temperature of (TD2) does not increase despite compressor 2 being in operation.	<p>Check installation of TD2 sensor. Check connection of TD2 sensor connector and wiring. Check resistance characteristics of TD2 sensor. Check for defect in outdoor P.C. board (I/F).</p>

Main remote controller	Check code		Location of detection	Description	System status	Error detection condition(s)	Check items (locations)
	Outdoor 7-segment display						
	Check code	Sub-code					
H16	H16	SMMS (1 series) 01: TK1 oil circuit error 02: TK2 oil circuit error 03: TK3 oil circuit error 04: TK4 oil circuit error	I/F	Oil detection circuit error	All stop	The temperature change of TK1 cannot be detected even after Compressor 1 starts operating.	Check the TK1 sensor installation. Check the TK1 sensor resistant characteristics. Check the misconnection of TK1, TK2, TK3, or TK4. Check the SV3E valve error. Check the oil circuit capillary clogging and non-return valve error Check the hibernating refrigerant in compressor.
		SMMS (1 series) 01: TK1 oil circuit error 02: TK2 oil circuit error 03: TK3 oil circuit error 04: TK4 oil circuit error	I/F	Oil detection circuit error	All stop	The temperature change of TK2 cannot be detected even after Compressor 2 starts operating.	Check the TK2 sensor installation. Check the TK2 sensor resistant characteristics. Check the misconnection of TK1, TK2, TK3, or TK4. Check the SV3E valve error. Check the oil circuit capillary clogging and non-return valve error. Check the hibernating refrigerant in compressor.
						The temperature change of TK3 cannot be detected even after Compressor 3 starts operating.	Check the TK3 sensor installation. Check the TK3 sensor resistant characteristics. Check the misconnection of TK1, TK2, TK3, or TK4. Check the SV3E valve error. Check the oil circuit capillary clogging and non-return valve error. Check the hibernating refrigerant in compressor.
						The temperature change of TK4 cannot be detected even after Compressor 4 starts operating, or the temperature difference from that of the other TK sensor changes only in the specified range for a given time or longer.	Check the TK4 sensor installation. Check the TK4 sensor resistant characteristics. Check the misconnection of TK1, TK2, TK3, or TK4. Check the SV3E valve error. Check the oil circuit capillary clogging and non-return valve error. Check the hibernating refrigerant in compressor.
		SMMS-i (4 series) 01: TK1 oil circuit error 02: TK2 oil circuit error 03: TK3 oil circuit error 04: TK4 oil circuit error 05: TK5 oil circuit error	I/F	Oil level detection circuit error	All stop	No temperature change is detected by TK1 despite compressor 1 having been started.	Check for disconnection of TK1 sensor. Check resistance characteristics of TK1 sensor. Check for connection error involving TK1, TK2, TK3, TK4, and TK5 sensors Check for faulty operation in SV3E or SV3F valve. Check for clogging in oil equalizing circuit capillary and faulty operation in check valve. Check for refrigerant entrapment inside compressor.
						No temperature change is detected by TK2 despite compressor 2 having been started.	Check for disconnection of TK2 sensor. Check resistance characteristics of TK2 sensor. Check for connection error involving TK1, TK2, TK3, TK4, and TK5 sensors Check for faulty operation in SV3E or SV3F valve. Check for clogging in oil equalizing circuit capillary and faulty operation in check valve. Check for refrigerant entrapment inside compressor.
						No temperature change is detected by TK3 despite compressor 3 having been started.	Check for disconnection of TK3 sensor. Check resistance characteristics of TK3 sensor. Check for connection error involving TK1, TK2, TK3, TK4, and TK5 sensors Check for faulty operation in SV3E or SV3F valve. Check for clogging in oil equalizing circuit capillary and faulty operation in check valve. Check for refrigerant entrapment inside compressor.

Main remote controller	Check code		Location of detection	Description	System status	Error detection condition(s)	Check items (locations)
	Outdoor 7-segment display						
	Check code	Sub-code					
H16	H16	SMMS-i (4 series) 01: TK1 oil circuit error 02: TK2 oil circuit error 03: TK3 oil circuit error 04: TK4 oil circuit error 05: TK5 oil circuit error	I/F	Oil level detection circuit error	All stop	No temperature change is detected by TK4 despite compressor having been started.	Check for disconnection of TK4 sensor. Check resistance characteristics of TK4 sensor. Check for connection error involving TK1, TK2, TK3, TK4, and TK5 sensors Check for faulty operation in SV3E or SV3F valve. Check for clogging in oil equalizing circuit capillary and faulty operation in check valve. Check for refrigerant entrapment inside compressor.
						No temperature change is detected by TK5 despite compressor having been started.	Check for disconnection of TK5 sensor. Check resistance characteristics of TK5 sensor. Check for connection error involving TK1, TK2, TK3, TK4, and TK5 sensors Check for faulty operation in SV3E valve. Check for clogging in oil equalizing circuit capillary and faulty operation in check valve. Check for refrigerant entrapment inside compressor.
H25	H25	–	I/F	TD3 sensor miswiring (incomplete insertion)	All stop	Air discharge temperature (TD3) does not increase despite compressor 3 being in operation.	Check installation of TD3 sensor. Check connection of TD3 sensor connector and wiring. Check resistance characteristics of TD3 sensor. Check for defect in outdoor P.C. board (I/F).
L02	L02	–	Indoor unit	Outdoor unit model mismatch error	Only the target unit stopped	An error was found on the outdoor unit model.	Check the model name of the outdoor unit. Check the miswiring of the communication line between indoor and outdoor.
L03	–	–	Indoor unit	Duplicated indoor header unit	Stop of corresponding unit	There is more than one header unit in group.	Check indoor addresses. Check for any change made to remote controller connection (group / individual) since indoor address setting.
L04	L04	–	I/F	Duplicated outdoor line address	All stop	There is duplication in line address setting for outdoor units belonging to different refrigerant piping systems.	Check line addresses.
L05	–	–	I/F	Duplicated priority indoor unit (as displayed on priority indoor unit)	All stop	More than one indoor unit has been set up as priority indoor unit.	Check display on priority indoor unit.
L06	L06	No. of priority indoor units	I/F	Duplicated priority indoor unit (as displayed on indoor unit other than priority indoor unit)	All stop	More than one indoor unit have been set up as priority indoor unit.	Check displays on priority indoor unit and outdoor unit.
L07	–	–	Indoor unit	Connection of group control cable to stand-alone indoor unit	Stop of corresponding unit	There is at least one stand-alone indoor unit to which group control cable is connected.	Check indoor addresses.
L08	L08	–	Indoor unit	Indoor group / addresses not set	Stop of corresponding unit	Address setting has not been performed for indoor units.	Check indoor addresses. Note: This code is displayed when power is turned on for the first time after installation.
L09	–	–	Indoor unit	Indoor capacity not set	Stop of corresponding unit	Capacity setting has not been performed for indoor unit.	Set indoor capacity. (DN = 11)

Main remote controller	Check code		Location of detection	Description	System status	Error detection condition(s)	Check items (locations)																																																																																			
	Outdoor 7-segment display																																																																																									
	Check code	Sub-code																																																																																								
L10	L10	—	I/F	Outdoor capacity not set	All stop	Jumper wire provided on P.C. board for servicing I/F P.C. board has not been removed as required for given model.	Check model setting of P.C. board for servicing outdoor I/F P.C. board.																																																																																			
L17	L17	Target indoor address	I/F	Outdoor unit model mismatch error		The outdoor unit model is duplicate. The Cool/Heat Flex series 1/2 are duplicate.	Check the outdoor unit model.																																																																																			
L18	L18	—	I/F	Cool / heat switch unit error	Only the target unit stopped	The heating operation was performed without the cool-only setting configured in a cool-only room where a cool/heat switch unit is not connected.	Check the remote controller setting. (DN="0F") Check the cool / heat switching unit. Check the piping connection of the switching unit. (Miswiring of discharge gas / suction gas) Check the SVS / SVD valve miswiring / misinstallation.																																																																																			
L20	—	—	AI-NET Indoor unit	Duplicated central control address	All stop	There is duplication in central control address setting.	Check central control addresses. Check network adaptor P.C. board (applicable to AI-NET).																																																																																			
L28	L28	—	I/F	Too many outdoor units connected	All stop	There are more than four outdoor units.	Check No. of outdoor units connected (Only up to 4 units per system allowed). Check communication lines between outdoor units. Check for defect in outdoor P.C. board (I/F).																																																																																			
L29	L29	SMMS (Series 1) 01: A3-IPDU1 error 02: A3-IPDU2 error 03: A3-IPDU1/A3-IPDU2 error 04: Fan IPDU error 05: A3-IPDU1 + Fan IPDU error 06: A3-IPDU2 + Fan IPDU error 07: All IPDU error or Communication error between IPDU and I/F circuit board or Outdoor I/F circuit board error SMMS-i (Series 4) <table border="1" style="margin-left: 20px;"> <thead> <tr> <th rowspan="2"></th> <th colspan="3">A3-IPDU</th> <th rowspan="2">Fan IPDU</th> </tr> <tr> <th>1</th> <th>2</th> <th>3</th> </tr> </thead> <tbody> <tr><td>01</td><td>○</td><td></td><td></td><td></td></tr> <tr><td>02</td><td></td><td>○</td><td></td><td></td></tr> <tr><td>03</td><td>○</td><td>○</td><td></td><td></td></tr> <tr><td>04</td><td></td><td></td><td>○</td><td></td></tr> <tr><td>05</td><td>○</td><td></td><td>○</td><td></td></tr> <tr><td>06</td><td></td><td>○</td><td>○</td><td></td></tr> <tr><td>07</td><td>○</td><td>○</td><td>○</td><td></td></tr> <tr><td>08</td><td></td><td></td><td></td><td>○</td></tr> <tr><td>09</td><td>○</td><td></td><td></td><td>○</td></tr> <tr><td>0A</td><td></td><td>○</td><td></td><td>○</td></tr> <tr><td>0B</td><td>○</td><td>○</td><td></td><td>○</td></tr> <tr><td>0C</td><td></td><td></td><td>○</td><td>○</td></tr> <tr><td>0D</td><td>○</td><td></td><td>○</td><td>○</td></tr> <tr><td>0E</td><td>○</td><td>○</td><td>○</td><td>○</td></tr> <tr><td>0F</td><td>○</td><td>○</td><td>○</td><td>○</td></tr> </tbody> </table> Symbol O signifies site of IPDU error.		A3-IPDU			Fan IPDU	1	2	3	01	○				02		○			03	○	○			04			○		05	○		○		06		○	○		07	○	○	○		08				○	09	○			○	0A		○		○	0B	○	○		○	0C			○	○	0D	○		○	○	0E	○	○	○	○	0F	○	○	○	○	I/F	Error in No. of IPDUs	All stop	Insufficient number of IPDUs are detected when power is turned on.	Check model setting of P.C. board for servicing outdoor I/F P.C. board. Check connection of UART communication connector. Check A3-IPDU, fan IPDU, and I/F P.C. board for defect.
	A3-IPDU			Fan IPDU																																																																																						
	1	2	3																																																																																							
01	○																																																																																									
02		○																																																																																								
03	○	○																																																																																								
04			○																																																																																							
05	○		○																																																																																							
06		○	○																																																																																							
07	○	○	○																																																																																							
08				○																																																																																						
09	○			○																																																																																						
0A		○		○																																																																																						
0B	○	○		○																																																																																						
0C			○	○																																																																																						
0D	○		○	○																																																																																						
0E	○	○	○	○																																																																																						
0F	○	○	○	○																																																																																						

Check code		Location of detection	Description	System status	Error detection condition(s)	Check items (locations)	
Main remote controller	Outdoor 7-segment display						
	Check code						Sub-code
L30	L30	Detected indoor address	Indoor unit	External interlock of indoor unit	Stop of corresponding unit	Signal is present at external error input terminal (CN80) for 1 minute.	When external device is connected to CN80 connector: 1) Check for defect in external device. 2) Check for defect in indoor P.C. board. When external device is not connected to CN80 connector: 1) Check for defect in indoor P.C. board.
–	L31	–	I/F	Extended IC error	Continued operation	There is part failure in P.C. board (I/F).	Check outdoor P.C. board (I/F).
P01	–	–	Indoor unit	Indoor fan motor error	Stop of corresponding unit		Check the lock of fan motor (AC fan). Check wiring.
P03	P03	–	I/F	Discharge temperature TD1 error	All stop	Discharge temperature (TD1) exceeds 115 °C.	Check outdoor service valves (gas side, liquid side) to confirm full opening. Check outdoor PMVs (PMV1, 2, 4) for clogging. Check resistance characteristics of TD1 sensor. Check for insufficiency in refrigerant quantity. Check for defect in 4-way valve. Check for leakage of SV4 circuit. Check SV4 circuit (wiring or installation error in SV41, SV42 or SV43).
P04	P04	01: Compressor 1 side 02: Compressor 2 side 03: Compressor 3 side	IPDU	Activation of high-pressure SW	All stop	High-pressure SW is activated.	Check connection of high-pressure SW connector. Check for defect in Pd pressure sensor. Check outdoor service valves (gas side, liquid side) to confirm full opening. Check for defect in outdoor fan. Check for defect in outdoor fan motor. Check outdoor PMVs (PMV1, 2) for clogging. Check indoor / outdoor heat exchangers for clogging. Check for short-circuiting of outdoor suction / discharge air flows. Check SV2 circuit for clogging. Check for defect in outdoor P.C. board (I/F). Check for error in indoor fan system (possible cause of air flow reduction). Check opening status of indoor PMV. Check indoor-outdoor communication line for wiring error. Check for faulty operation of check valve in discharge pipe convergent section. Check gas balancing SV4 valve circuit. Check SV5 valve circuit. Check for refrigerant overcharging.

Main remote controller	Check code		Location of detection	Description	System status	Error detection condition(s)	Check items (locations)
	Outdoor 7-segment display						
	Check code	Sub-code					
P05	P05	SMMS (Series 1) 01: Open phase detected 02: Phase sequence error	I/F	Open phase detected, Phase sequence error	All stop	Phase sequence error was detected when the power is turned on. Open phase error was detected when the power is turned on.	Check the phase sequence of outdoor power wiring. Check the outdoor PC board (I/F) error.
		SMMS-i (Series 4) 00:	I/F	Detection of open phase / phase sequence	All stop	Open phase is detected when power is turned on. Inverter DC voltage is too high (overvoltage) or too low (undervoltage).	Check for defect in outdoor P.C. board (I/F).
		01: Compressor 1 side 02: Compressor 2 side 03: Compressor 3 side		Inverter DC voltage (Vdc) error (compressor) MG-CTT error			
P07	P07	01: Compressor 1 side 02: Compressor 2 side 03: Compressor 3 side	IPDU I/F	Heat sink overheating error	All stop	Temperature sensor built into IGBT (TH) is overheated.	Check power supply voltage. Check outdoor fan system error. Check heat sink cooling duct for clogging. Check IGBT and heat sink for thermal performance for faulty installation. (e.g. mounting screws and thermal conductivity) Check for defect in A3-IPDU. (faulty IGBT built-in temperature sensor (TH))
P10	P10	Detected indoor address	Indoor unit	Indoor overflow error	All stop	Float switch operates. Float switch circuit is open-circuited or disconnected at connector.	Check float switch connector. Check operation of drain pump. Check drain pump circuit. Check drain pipe for clogging. Check for defect in indoor P.C. board.
P12	—	—	Indoor unit	Indoor fan motor error	Stop of corresponding unit	Motor speed measurements continuously deviate from target value. Overcurrent protection is activated.	Check connection of fan connector and wiring. Check for defect in fan motor. Check for defect in indoor P.C. board. Check impact of outside air treatment (OA). Check static pressure setting.

MG-CTT: Magnet contactor

Main remote controller	Check code		Location of detection	Description	System status	Error detection condition(s)	Check items (locations)
	Outdoor 7-segment display						
	Check code	Sub-code					
P13	P13	—	I/F	Outdoor liquid backflow detection error	All stop	<p><During cooling operation> When system is in cooling operation, high pressure is detected in follower unit that has been turned off.</p> <p><During heating operation> When system is in heating operation, outdoor PMV 1 or 2 continuously registers opening of 100p or less while under SH control.</p>	<p>Check full-close operation of outdoor PMV (1, 2, 4). Check for defect in Pd or Ps sensor. Check gas balancing circuit (SV2) for clogging. Check balance pipe. Check SV3B circuit for clogging. Check defect in outdoor P.C. board (I/F). Check capillary of oil separator oil return circuit for clogging. Check for leakage of check valve in discharge pipe convergent section.</p>
P15	P15	01: TS condition	I/F	Gas leakdetection (TS1 condition)	All stop	<p>Protective shutdown due to sustained suction temperature at or above judgment criterion for at least 10 minutes is repeated four times or more. <TS error judgment criterion> In cooling operation: 60 °C In heating operation: 40 °C</p>	<p>Check for insufficiency in refrigerant quantity. Check outdoor service valves (gas side, liquid side) to confirm full opening. Check PMVs (PMV1, 2) for clogging. Check resistance characteristics of TS1 sensor. Check for defect in 4-way valve. Check SV4 circuit for leakage</p>
		02: TD condition	I/F	Gas leak detection (TD condition)	All stop	<p>Protective shutdown due to sustained discharge temperature (TD1, TD2 or TD3) at or above 108 °C for at least 10 minutes is repeated four times or more.</p>	<p>Check for insufficiency in refrigerant quantity. Check PMVs (PMV 1, 2) for clogging. Check resistance characteristics of TD1, TD2 and TD3 sensors. Check indoor filter for clogging. Check piping for clogging. Check SV4 circuit (for leakage or coil installation error).</p>
P17	P17	—	I/F	Discharge temperature TD2 error	All stop	Discharge temperature (TD2) exceeds 115 °C.	<p>Check outdoor service valves (gas side, liquid side) to confirm full opening. Check outdoor PMVs (PMV1, 2, 4) for clogging. Check resistance characteristics of TD2 sensor. Check for defect in 4-way valve. Check SV4 circuit for leakage. Check SV4 circuit (for wiring or installation error involving SV41, SV42 and SV43).</p>
P18	P18	—	I/F	Discharge temperature TD3 error	All stop	Discharge temperature (TD3) exceeds 115 °C.	<p>Check outdoor service valves (gas side, liquid side) to confirm full opening. Check outdoor PMVs (PMV1, 2, 4) for clogging. Check resistance characteristics of TD3 sensor. Check for defect in 4-way valve. Check SV43 circuit for leakage. Check SV4 circuit (for wiring or installation error involving SV41, SV42 and SV43).</p>

Main remote controller	Check code		Location of detection	Description	System status	Error detection condition(s)	Check items (locations)
	Outdoor 7-segment display						
	Check code	Sub-code					
P19	P19	Detected outdoor unit No.	I/F	4-way valve reversing error	All stop	Abnormal refrigerating cycle data is collected during heating operation.	Check for defect in main body of 4-way valve. Check for coil defect in 4-way valve and loose connection of its connector. Check resistance characteristics of TS1 and TE1 sensors. Check output voltage characteristics of Pd and Ps pressure sensors. Check for wiring error involving TE1 and TL sensors.
P20	P20	—	I/F	Activation of high-pressure protection	All stop	Pd sensor detects pressure equal to or greater than 3.6 MPa.	Check for defect in Pd pressure sensor. Check service valves (gas side, liquid side) to confirm full opening. Check for defect in outdoor fan. Check for defect in outdoor fan motor. Check outdoor PMVs (PMV1, 2, 4) for clogging. Check indoor / outdoor heat exchangers for clogging. Check for short-circuiting of outdoor suction / discharge air flows. Check SV2 circuit for clogging. Check for defect in outdoor P.C. board (I/F). Check for defect in indoor fan system (possible cause of air flow reduction). Check opening status of indoor PMV. Check indoor-outdoor communication line for wiring error. Check for faulty operation of check valve in discharge pipe convergent section. Check gas balancing SV4 valve circuit. Check SV5 valve circuit. Check for refrigerant overcharging.

		Check code		Location of detection	Description	System status	Error detection condition(s)	Check items (locations)
Main remote controller	Outdoor 7-segment display							
	Check code	Sub-code						
P22	P22	SMMS (Series 1) 08: Out of step 0A: IDC activation 0E: Sync error 0F: Control error 06: Maximum rotation exceeded 04: Rotation difference error 0D: Lock 0C: Fan lock	PDU	Outdoor fan IPDU error	All stop	(Sub code: 08) FAN IPDU position detection circuit Position detection is not performed properly.	Check the fan motor. Check the connector connection for fan motor. Check the error of IPDU board for fan.	
					All stop	(Sub code: 0A) FAN IPDU overcurrent protection circuit Overcurrent was detected when the fan started running or during operation.	Check the fan motor. Check the error of IPDU board for fan.	
					All stop	(Sub code: 0E) FAN IPDU position detection circuit Position detection is not performed properly.	Check the fan motor. Check the connector connection for fan motor. Check the error of IPDU board for fan.	
					All stop	(Sub code: 0F) FAN IPDU position detection circuit Position detection is not performed properly.	Check the fan motor. Check the connector connection for fan motor. Check the error of IPDU board for fan.	
					All stop	(Sub code: 06) External factors such as blast Position detection is not performed properly. (Restarted in 6 seconds)	Check the fan motor. Check the error of IPDU board for fan.	
					All stop	(Sub code: 04) External factors such as blast The difference between targeted rotation and actual rotation is 25% or more. (Restarted in 6 seconds)	Check the fan motor. Check the error of IPDU board for fan.	
					All stop	(Sub code: 0D) FAN IPDU position detection circuit Position detection is not performed properly. (No wind)	Check the fan motor. Check the connector connection for fan motor. Check the error of IPDU board for fan.	
					All stop	(Sub code: 0C) External factors such as blast Position detection is not performed properly. (Wind blows) (Restarted in 6 seconds)	Check the fan motor. Check the error of IPDU board for fan.	

Check code		Location of detection	Description	System status	Error detection condition(s)	Check items (locations)	
Main remote controller	Outdoor 7-segment display						
	Check code	Sub-code					
P22	P22	SMMS-i (Series 4) 0*: IGBT circuit 1*: Position detection circuit error 3*: Motor lockup error 4*: Motor current detection C*: TH sensor temperature error D*: TH sensor error E*: Inverter DC voltage error (outdoor fan) Note: Although letters 0 to F appear at locations indicated by " * ", please ignore them.	IPDU	Outdoor fan IPDU error	All stop	(Sub code: 0*) Fan IPDU over current protection circuit Flow of current equal to or greater than the specified value is detected during startup of the fan.	Check fan motor. Check for defect in fan IPDU P.C. board.
					All stop	(Sub code: 1*) Fan IPDU position detection circuit Position detection is not going on normally.	Check fan motor. Check connection of fan motor connector. Check for defect in fan IPDU P.C. board.
					All stop	(Sub code: 3*) Gusty wind, an obstruction, or another external factor Speed estimation is not going on normally.	Check fan motor. Check for defect in fan IPDU P.C. board.
					All stop	(Sub code: 4*) Fan IPDU over current protection circuit Flow of current equal to or greater than the specified value is detected during operation of the fan.	Check fan motor. Check connection of fan motor connector. Check for defect in fan IPDU P.C. board.
					All stop	(Sub code: C*) Higher temperature than the specified value is detected during operation of the fan.	Check fan motor. Check for defect in fan IPDU P.C. board.
					All stop	(Sub code: D*) The resistance value of the sensor is infinite or zero (open or short circuit).	Check for defect in fan IPDU P.C. board.
					All stop	(Sub code: E*) Fan IPDU DC voltage protection circuit The DC voltage higher or lower than the specified value is detected.	Check power voltage of the main power supply. Check for defect in fan IPDU P.C. board. Check connection of fan IPDU P.C. board.
P26	P26	01: Compressor 1 side 02: Compressor 2 side 03: Compressor 3 side	IPDU	G-TR shortcircuit protection error	All stop	Overcurrent is momentarily detected during startup of compressor.	Check connector connection and wiring on A3-IPDU P.C. board. Check for defect in compressor (layer short-circuit). Check for defect in outdoor P.C. board (A3-IPDU).
P29	P29	01: Compressor 1 side 02: Compressor 2 side 03: Compressor 3 side	IPDU	Compressor position detection circuit error	All stop	Position detection is not going on normally.	Check wiring and connector connection. Check for compressor layer short-circuit. Check for defect in A3-IPDU P.C. board.
P31	—	—	Indoor unit	Other indoor error (group follower unit error)	Stop of corresponding unit	There is error in other indoor unit in group, resulting in detection of E07/L07/L03/L08.	Check indoor P.C. board.

Errors detected by TCC-LINK central control device

Check code		Location of detection	Description	System status	Error detection condition(s)	Check items (locations)
Main remote controller	Outdoor 7-segment display					
	Check code	Sub-code				
C05	–		TCC-LINK TCC-LINK central control device transmission error	Continued operation	Central control device is unable to transmit signal.	Check for defect in central control device. Check for defect in central control communication line. Check termination resistance setting.
C06	–		TCC-LINK TCC-LINK central control device reception error	Continued operation	Central control device is unable to receive signal.	Check for defect in central control device. Check for defect in central control communication line. Check termination resistance setting. Check power supply for devices at other end of central control communication line. Check defect in P.C. boards of devices at other end of central control communication line.
C12	–		General-purpose device I/F Blanket alarm for general-purpose device control interface	Continued operation	Error signal is input to control interface for general-purpose devices.	Check error input.
P30	Differs according to nature of alarm-causing error		TCC-LINK Group control follower unit error	Continued operation	Error occurs in follower unit under group control. ([P30] is displayed on central control remote controller.)	Check check code of unit that has generated alarm.
	(L20 displayed.)			Duplicated central control address	Continued operation	There is duplication in central control addresses.

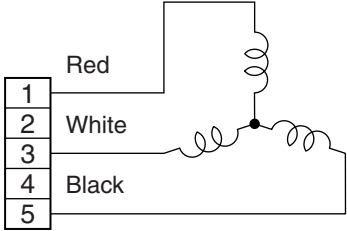
Part name	Checking procedure																
Concealed Duct type Fan motor ICF-340W150-2 (MMD-AP0076BHP1* AP0096BHP1* AP0126BHP1* AP0156BHP1* AP0186BHP1*) ICF-340W150-1 (MMD-AP0246BHP1* AP0276BHP1* AP0276BHP1*) ICF-340W250-1 (MMD-AP0366BHP1* AP0486BHP1* AP0566BHP1*)	Measure the resistance value of each winding by using the tester. <div style="display: flex; justify-content: space-between;"> <div style="width: 45%;"> <p data-bbox="443 477 790 504">Fan motor inside wiring diagram</p>  </div> <div style="width: 45%;"> <p data-bbox="906 297 1109 324">ICF-340W150-1, 2</p> <table border="1" data-bbox="898 331 1428 533"> <thead> <tr> <th>Position</th> <th>Resistance value</th> </tr> </thead> <tbody> <tr> <td>Black-Red</td> <td>14.8 ± 1.5 Ω</td> </tr> <tr> <td>Black-White</td> <td>14.8 ± 1.5 Ω</td> </tr> <tr> <td>Red-White</td> <td>14.8 ± 1.5 Ω</td> </tr> </tbody> </table> <p data-bbox="906 566 1077 593">ICF-340W250-1</p> <table border="1" data-bbox="898 600 1428 801"> <thead> <tr> <th>Position</th> <th>Resistance value</th> </tr> </thead> <tbody> <tr> <td>Black-Red</td> <td>12.4 ± 1.2 Ω</td> </tr> <tr> <td>Black-White</td> <td>12.4 ± 1.2 Ω</td> </tr> <tr> <td>Red-White</td> <td>12.4 ± 1.2 Ω</td> </tr> </tbody> </table> </div> </div>	Position	Resistance value	Black-Red	14.8 ± 1.5 Ω	Black-White	14.8 ± 1.5 Ω	Red-White	14.8 ± 1.5 Ω	Position	Resistance value	Black-Red	12.4 ± 1.2 Ω	Black-White	12.4 ± 1.2 Ω	Red-White	12.4 ± 1.2 Ω
Position	Resistance value																
Black-Red	14.8 ± 1.5 Ω																
Black-White	14.8 ± 1.5 Ω																
Red-White	14.8 ± 1.5 Ω																
Position	Resistance value																
Black-Red	12.4 ± 1.2 Ω																
Black-White	12.4 ± 1.2 Ω																
Red-White	12.4 ± 1.2 Ω																
	Under 20 °C																

9-5. Sensor characteristics

Indoor unit

▼ Temperature sensor characteristics

Indoor TA sensor

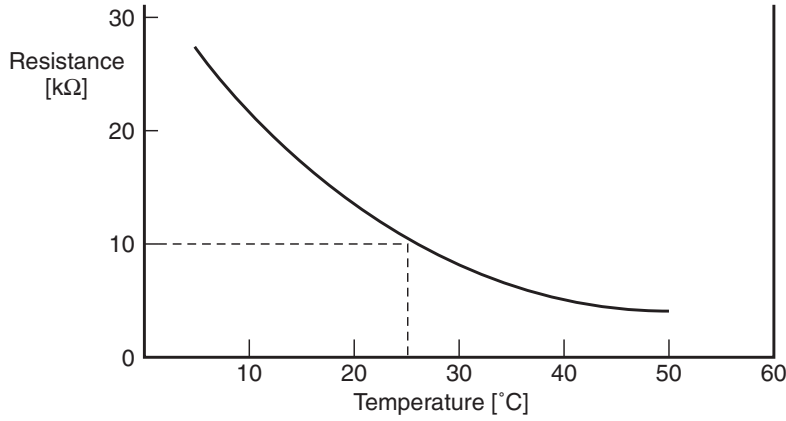

Temperature [°C]	Resistance [kΩ]
0	33.9
5	26.1
10	20.3
15	15.9
20	12.6
25	10.0
30	8.0
35	6.4
40	5.2
45	4.2
50	3.5
55	2.6
60	2.4

Indoor TC1 sensor

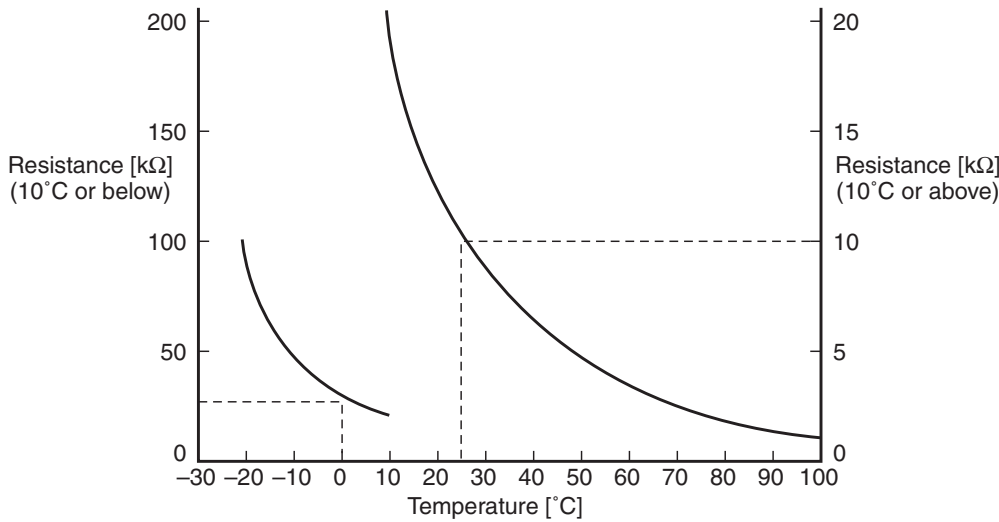

Temperature [°C]	Resistance [kΩ]
-20	99.9
-15	74.1
-10	55.6
-5	42.2
0	32.8
5	25.4
10	19.8
15	15.6
20	12.4
25	10.0
30	8.1
35	6.5
40	5.3
45	4.4
50	3.6
55	3.0
60	2.5
65	2.1
70	1.8
75	1.5
80	1.3
85	1.1
90	1.0
95	0.8
100	0.7

Indoor TC2 and TCJ sensors

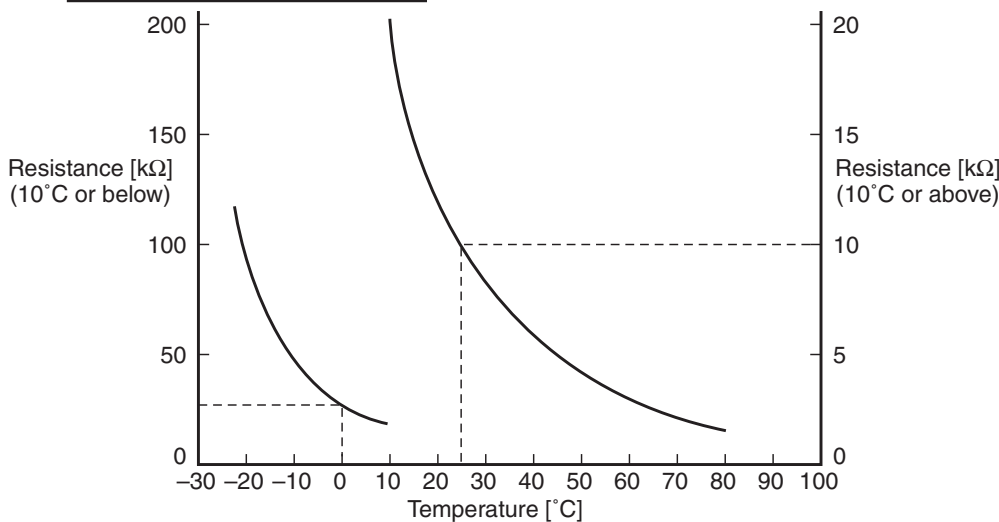

Temperature [°C]	Resistance [kΩ]
-20	115.2
-15	84.2
-10	62.3
-5	46.6
0	35.2
5	26.9
10	20.7
15	16.1
20	12.6
25	10.0
30	8.0
35	6.4
40	5.2
45	4.2
50	3.5
55	2.8
60	2.4
65	2.0
70	1.6
75	1.4
80	1.2

10. P.C. BOARD EXCHANGE PROCEDURES

■ Indoor unit

10-1. Replacement of indoor P.C. boards

Part code	Model type	P.C. board type
43T6V689	MMD-AP**6 BHP1*s eries	MCC-1631

Points to note when replacing indoor P.C. board assembly

The electrically erasable programmable read-only memory (hereinafter EEPROM) mounted on an indoor P.C. board holds important setting data, including the type and capacity codes intrinsic to the model (set at the factory), as well as the line / indoor / group addresses, high ceiling adjustment setting and the like (during installation, either automatically or manually). Proceed with the replacement of an indoor P.C. board assembly in accordance with the procedure described below.

After completion of the work, check the settings again, including the indoor unit No. and group header / follower designation, and confirm the integrity of the refrigerating cycle by conducting a test operation, etc.

<Replacement procedure>

Method 1

If it is possible to turn on the indoor unit and read the setting data from the P.C. board to be replaced via a wired remote controller -

Reading EEPROM data: **Procedure 1**



Replacing P.C. board and turning on power: **Procedure 2**



Writing EEPROM data in new EEPROM: **Procedure 3**



Resetting power supply (applicable to all indoor units connected to remote controller in case of group operation)

Method 2

If it is not possible to turn on the indoor unit or read the setting data from the P.C. board to be replaced via a wired remote controller or operate the remote controller due to the failure of its power supply circuit -

Replacing EEPROM (For the location of this component and the method to replace it, see the “EEPROM location diagram” section.)

- The EEPROM on the P.C. board to be replaced needs to be removed and mounted on the service P.C. board.



Replacing P.C. board and turning on power: **Procedure 2**



Reading EEPROM data: **Procedure 1**

- If data cannot be read, go to Method 3.



Replacing EEPROM again (For the location of this component and the method to replace it, see the “EEPROM location diagram” section.)

- The old EEPROM, supplied with the P.C. board to be replaced and now mounted on the service P.C. board, needs to be replaced with the new EEPROM, supplied with the service P.C. board.



Replacing P.C. board and turning on power: **Procedure 2**



Writing EEPROM data in new EEPROM: **Procedure 3**



Resetting power supply (applicable to all indoor units connected to remote controller in case of group operation)

Method 3

If it is not possible to read the setting data due to the failure of the EEPROM itself -

Replacing P.C. board and turning on power: **Procedure 2**



Writing EEPROM data on basis of information supplied by customer (e.g. External static pressure selection setting and optional connection setting): **Procedure 3**



Resetting power supply (applicable to all indoor units connected to remote controller in case of group operation)

<EEPROM layout>

EEPROM is attached to IC socket. To remove it, use a pair of tweezers, etc.





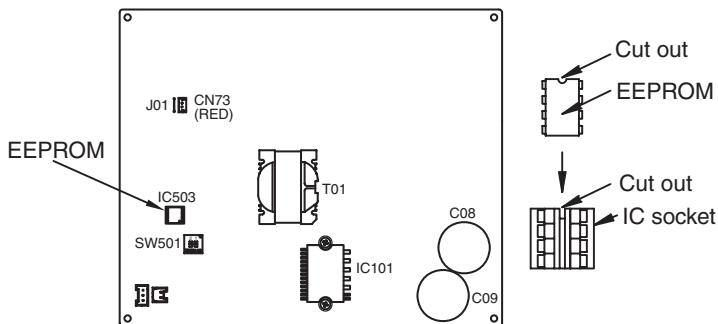

To attach EEPROM, arrange the direction as shown in the following figures.

” In exchanging time, pay attention not to bend the lead wire of IC.



Procedure 1: reading setting data from EEPROM

(Read the setting data from EEPROM, including both the factory settings and any modifications made to them on site.)

- 1** Push the  +  +  buttons simultaneously and hold for at least 4 seconds. (This number corresponds to the same number shown on the Remote Controller Operation Diagram.)
 - * In the case of group control, the unit No. displayed first is the indoor unit No. of the header unit.
At the same time, the CODE No. (DN code) 10 is displayed, and the fan of the selected indoor unit comes on, with the louver swinging, depending on the model.
- 2** Each time the  button (left side of the button) is pushed, one of the indoor unit No. under group control is displayed in turn.
 - * The fan of the selected indoor unit comes on, with the louvers swinging, depending on the model.
- 3** The  button allows you to move the CODE No. (DN code) up / down by one place.
- 4** First, change the CODE No. (DN code) from 10 to 01. (To set filter sign lighting time)
Jot down the setting data displayed.
- 5** Change the CODE No. (DN code) using the  button.
Again, jot down the setting data displayed.
- 6** Repeat step 5 until all the setting data has been jotted down. (See the CODE No. list.)
 - * CODE No. (DN code) go from 01 to FF with a few gaps along the way.
- 7** When finished, push the  button to bring the system back to normal off state.
(It takes the system about 1 minute to become responsive to remote controller operation.)

CODE No. (DN code) necessary at minimum

DN	Contents
10	Type
11	Indoor unit capacity
12	Line address
13	Indoor address
14	Group address

The type and capacity of the indoor unit are necessary for fan speed setting.

Remote controller operation diagram

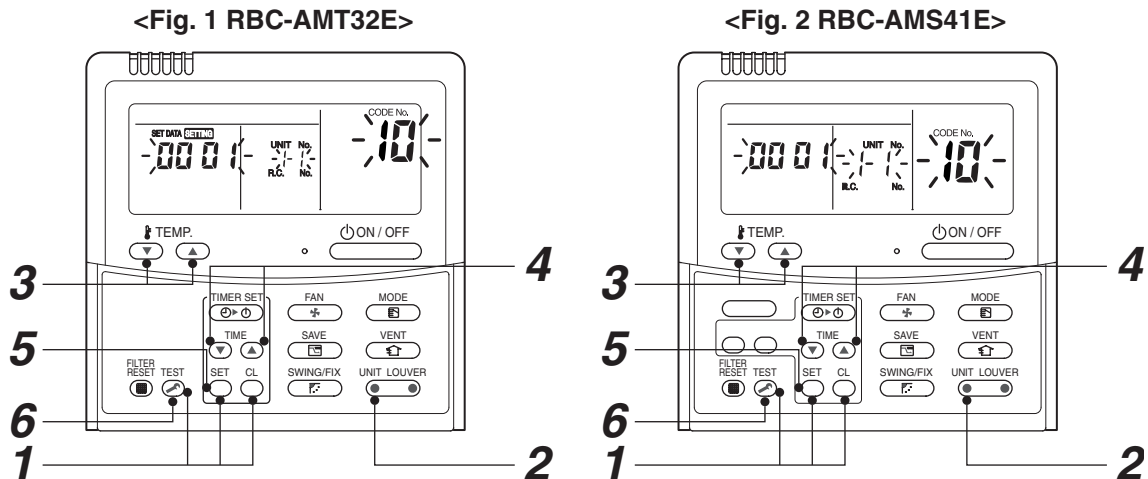

Procedure 2: replacing P.C. board

1 Replace the faulty P.C. board with a service P.C. board.

Be sure to replicate the old jumper setting (removal), switch setting (SW501), and connector short-circuit setting (e.g. CN34) on the service P.C. board. (See the diagram at below.)

⚠ CAUTION

Don't remove the materials.
No materials. The power I.C. (IC101) may break.

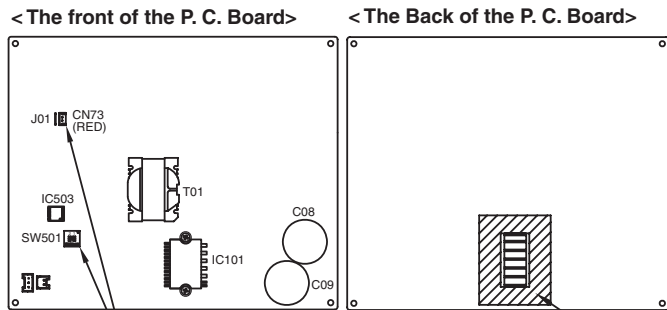

Perform the same setting of the jumper wire(J01) setting(cut), switch(SW501) as the setting of the P.C. board before replacement

Materials

2 It is necessary to establish a one-to-one correspondence between the indoor unit being serviced and the remote controller.

Turn on the indoor unit using one of the methods described below according to the system configuration.

(1) Single (stand-alone) operation

Turn on the indoor unit and proceed to **Procedure 3**.

(2) Group operation

A) If it is possible to selectively turn on the indoor unit being serviced

Turn on the indoor unit being serviced and proceed to **Procedure 3**.

B) If it is not possible to selectively turn on the indoor unit being serviced (**Case 1**)

a) Temporarily disconnect the group control wiring from terminals A and B of the indoor unit being serviced.

b) Connect the remote controller wiring to the terminals, turn on the indoor unit, and proceed to **Procedure 3**.

* If this method cannot be used, proceed to the alternative method described below (**Case 2**).

C) If it is not possible to selectively turn on the indoor unit being serviced (**Case 2**)

a) Remove the CN41 connectors of all other indoor units in the same group.

b) Turn on the indoor unit and proceed to **Procedure 3**.

Case 1

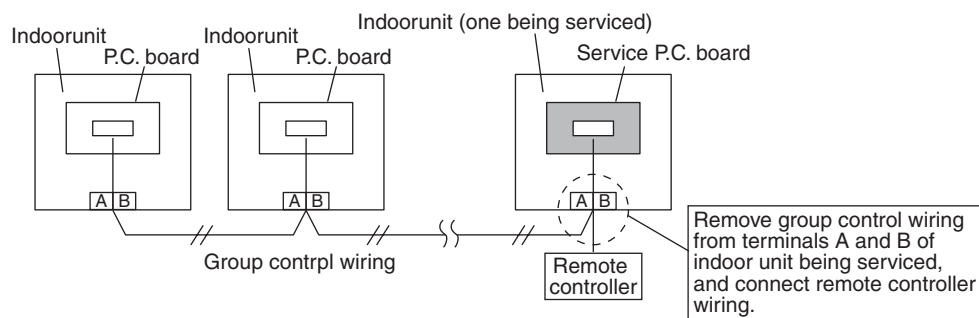

Case 2

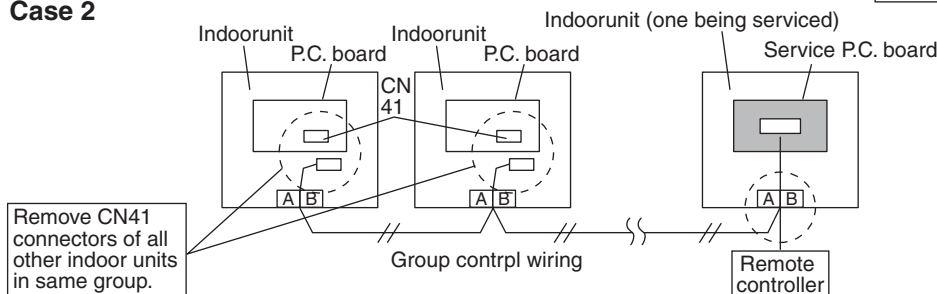

* Be sure to restore the temporarily removed group control wiring and CN41 connectors to their initial states after Procedure 3 has been completed.

Procedure 3: writing setting data in EEPROM

(The EEPROM of the service P.C. board has been set to the factory default values.)

- 1 Push the + + buttons simultaneously and hold for at least 4 seconds. (This number corresponds to the same number shown on the Remote Controller Operation Diagram.)

(Under UNIT No., ALL is displayed.)

At the same time, the CODE No. (DN code) 10 is displayed, and the fan of the indoor unit comes on, with the louver swinging, depending on the model.

- 2 Push the left part of the button (left side of the button) to display the indoor unit No. one by one in the group control. Specify the indoor unit No. whose service PC board was replaced.

(This operation is not available if the UNIT No. shows ALL.)

- 3 The button allows you to moved the CODE No. (DN code) up / down by one place.

- 4 First, set the type and capacity codes of the indoor unit.

(Changing the type and capacity codes in EEPROM overwrites the factory default settings.)

- (1) Set the CODE No. (DN code) to 10 (no change)
- (2) Use the button to select the type.
(For example, 0001 is for the 4-way cassette type.) - See the CODE No. list.
- (3) Push the button. (The display should change from flashing to steady.)
- (4) Use the button to set the CODE No. (DN code) to 11.
- (5) Use the button to set the capacity code.
(For example, 0012 is for the 027 type.) - See the CODE No. list.
- (6) Push the button. (The display should change from flashing to steady.)
- (7) Push the button to bring the system back to normal off state.

<Fig. 1 RBC-AMT32E>

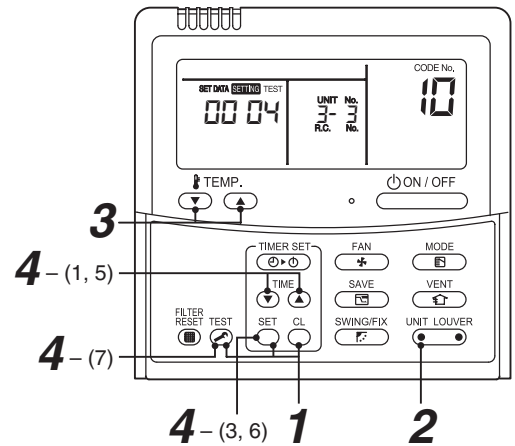

- 5 Next, write any setting changes made on-site after installation, such as address settings, in the EEPROM. Perform the tasks specified in step 1 again.

- 6 Use the button to set the CODE No. (DN code) to 01 (To set filter sign lighting time)

- 7 Check the value displayed with the value jotted down in Procedure 1 and information proved by the customer.

- (1) If there is a discrepancy, change the setting in accordance with the jotted-down value, and push the button.
(The display should change from flashing to steady.)

- (2) If there is no discrepancy, do nothing.

- 8 Use the button to change the CODE No. (DN code).

Again, check the value, and change the setting if necessary.

- 9 Repeat steps 6 and 7 until all the settings are checked.

- 10 When finished, push the button to bring the system back to normal off state.

In the case of group operation, turn the unit off, reconnect the indoor-indoor group control wiring and CN41 connectors, and turn on all the indoor units.

(It takes the system about 1 minute to become responsive to remote controller operation.)

- * CODE No. (DN code) go from 01 to FF with a few gaps along the way.

If you realize you have wrongly corrected a certain setting after pushing the , you can recover the initial value by pushing the , provided that the CODE No. (DN code) is yet to be changed.

<Fig. 1 RBC-AMT32E>

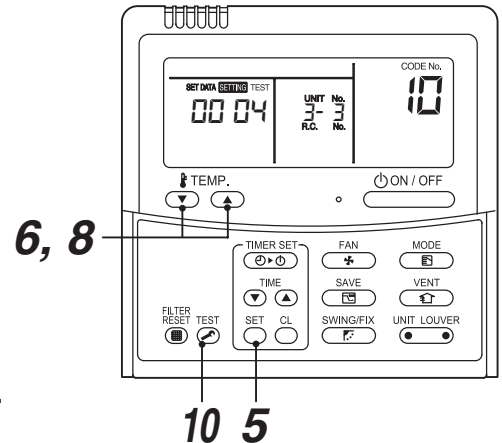

CODE No. list (Example)

CODE No. (DN)	Item	Setting data	Factory-set value
01	Filter sign lighting time		Depending on Type
02	Filter pollution leve		0000: standard
03	Central control address		0099: Not determined
06	Heating suction temperature shift		0002: +2 °C (Floor standing type: 0)
0d	Existence of automatic COOL/HEAT mode		0001: No auto mode cooling / heating
0F	Cooling only		0000: Heat pump
10	Type		Depending on model type
11	Indoor unit capacity		Depending on capacity type
12	System address		0099: Not determined
13	Indoor unit address		0099: Not determined
14	Group address		0099: Not determined
1E	Temperature range of cooling / heating automatic SW control point		0003: 3 deg (Ts } 1.5)
28	Power failure automatic recovery		0000: None
31	Vent Fan (Single operation)		0000: Not possible
32	Sensor SW (Selection of static pressure)		0000: Body sensor
5d	High ceiling select		0000: Standard
60	Timer setting (wired remote controller)		0000: Available
F0	Swing mode		0001: Standard
D0	Power save operation		0001: Standard

* Automatically selection by connected outdoor unit

Type Code No. [10]

Setting data	Type	Model abb. name
0004	Concealed Duct Standard	MMD-AP***BHP

Indoor unit capacity CODE No. [11]

Setting data	Model	Setting data	Model
0000*	Invalid	0016	—
0001	007 type	0017	048 type
0002	—	0018	056 type
0003	009 type	0019	—
0004	—	0020	—
0005	012 type	0021	072 ype
0006	—	0022	—
0007	015 type	0023	096 type
0008	—	0024	—
0009	018 type	0025	—
0010	—	0026	—
0011	024 type	0027	—
0012	027 type	0028	—
0013	030 type	~	—
0014	—	0034	—
0015	036 type		

11. DETACHMENTS

WARNING

Be sure to stop operation of the air conditioner before work and then turn off switch of the breaker.

CAUTION

Be sure to put on gloves during working time; otherwise an injury will be caused by a part, etc.

NOTE

In a section, Detachments, the models are expressed as follows for convenience.



AP007: MMD-AP0076BHP1-E(TR) to AP0186BHP1-E(TR)

AP024: MMD-AP0246BHP1-E(TR) to AP0306BHP1-E(TR)

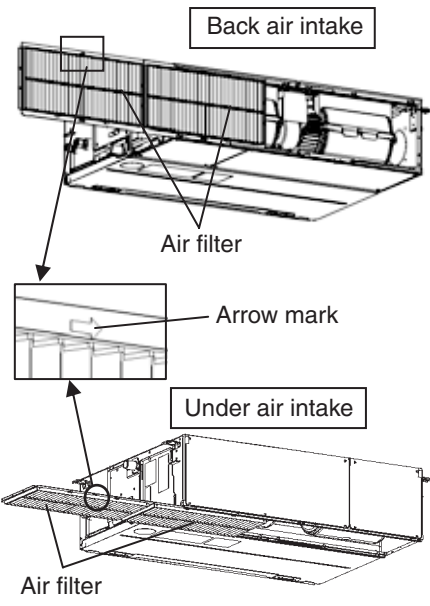

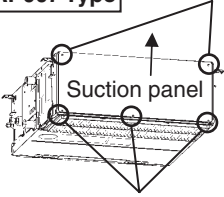
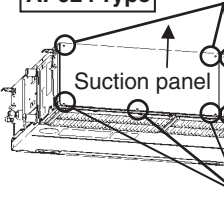
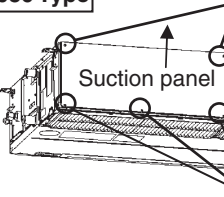
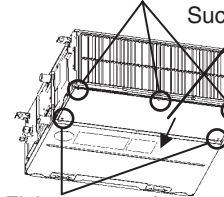
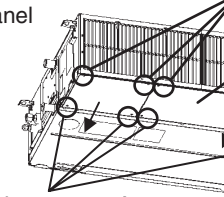
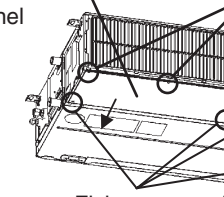
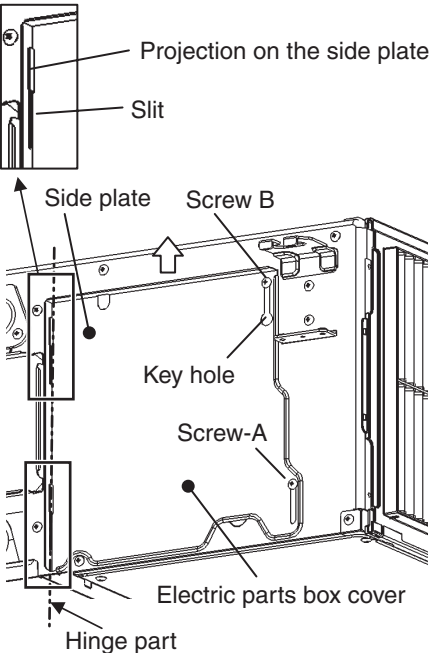
AP036: MMD-AP0366BHP1-E(TR) to AP0566BHP1-E(TR)

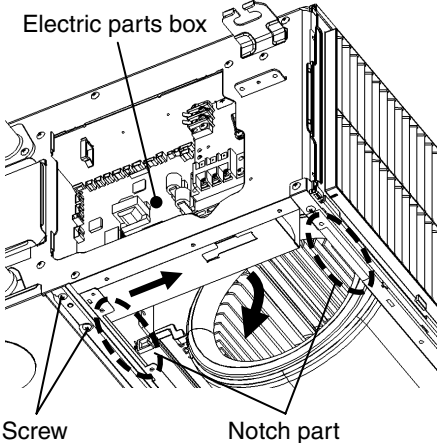
No.	Part name	Procedure	Remarks
①	Air filter	<p>1. Detachment</p> <p>1) Slide the filter toward the opposite side of the arrow mark and then pull out the filter. (In the case that two filters are provided, pull out the first filter, then the second filter will be pulled out connected with the first filter.)</p> <p>2. Attachment</p> <p>1) Insert the filter in the filter rail toward the arrow mark, slide it until the filter stops and then fix it. (In the case that two filters are provided, insert the second filter in the same direction after inserting the first filter.)</p>	 <p>The diagram illustrates the process of removing and installing an air filter. The top portion shows the 'Back air intake' with an 'Air filter' being pulled out. The bottom portion shows the 'Under air intake' with an 'Air filter' being inserted. An 'Arrow mark' is shown on the filter rail to indicate the correct direction of insertion.</p>

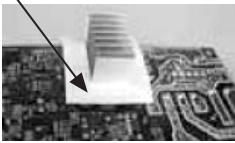
No.	Part name	Procedure	Remarks
②	Suction panel	<p>1. Detachment</p> <ol style="list-style-type: none"> 1) Remove the fixing screws A which fix the suction panel. Loosen the fixing screws B. 2) Slide the suction panel to the arrow side and then remove the panel. <p>2. Attachment</p> <ol style="list-style-type: none"> 1) Hook the suction panel to the fixing screws B and tighten screws. 2) Attach the removed screws A to the original positions. 	
<div style="display: flex; justify-content: space-around;"> <div style="text-align: center;"> <p>Under air intake</p> <p>AP007 Type</p>  <p>Fixing screws A</p> <p>Suction panel</p> <p>Fixing screws B</p> </div> <div style="text-align: center;"> <p>AP024 Type</p>  <p>Fixing screws A</p> <p>Suction panel</p> <p>Fixing screws B</p> </div> <div style="text-align: center;"> <p>AP036 Type</p>  <p>Fixing screws A</p> <p>Suction panel</p> <p>Fixing screws B</p> </div> </div> <div style="display: flex; justify-content: space-around; margin-top: 10px;"> <div style="text-align: center;"> <p>Back air intake</p>  <p>Fixing screws B</p> <p>Suction panel</p> <p>Fixing screws A</p> </div> <div style="text-align: center;">  <p>Fixing screws B</p> <p>Suction panel</p> <p>Fixing screws A</p> </div> <div style="text-align: center;">  <p>Suction panel</p> <p>Fixing screws B</p> <p>Fixing screws A</p> </div> </div>			
③	Electric parts box cover	<p>1. Detachment</p> <ol style="list-style-type: none"> 1) Remove the screw A of the electric parts box cover to loosen screw B. 2) As shown in the right figure, when sliding it toward arrow direction and pulling to this side, the electric parts cover opens using the hinge part as a shaft. 3) Take off the slit of the electric parts box cover from the projection of the side plate and then remove the cover. <p>2. Attachment</p> <ol style="list-style-type: none"> 1) Hook the slit of the electric parts box cover to the projection of the side plate, close the cover, enter screw B in the Key hole and then slide it. 2) Fix the electric parts box cover by tightening with screws A and B. 	

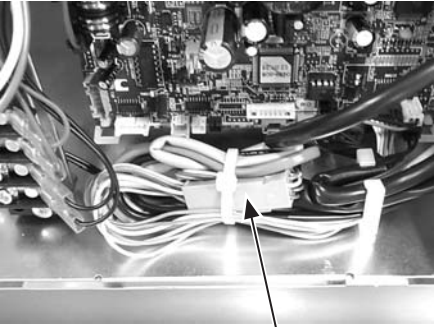
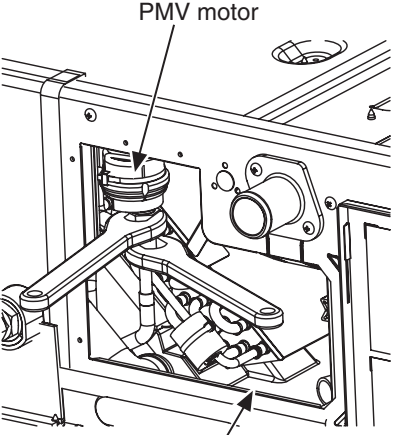
No.	Part name	Procedure	Remarks
④	Electric parts box	<p>1. Detachment</p> <ol style="list-style-type: none"> 1) Perform works of 1 of ①. (In case of under air intake) Perform works of 1 of ②. (In case of back air intake) Perform works of 1 of ③. 2) Remove the indoor/outdoor connecting wire and remote controller wire from each terminal block. 3) Remove the connectors which connected from the control P.C. board to other parts. <p>NOTE</p> <hr/> <p>First unlock the housing and then remove the connectors.</p> <hr/> <p>CN34 : Float switch (3P, Red) CN41 : Remote controller terminal block (3P, Blue) (Screw part of terminal block, 2P.) CN504 : Drain pump (2P, White) CN67 : Power supply terminal block (5P: Black) (Screw part of terminal block, 3P.) CN101 : TC sensor (2P: Black) CN102 : TCJ sensor (2P, Red) CN104 : Room temperature (2P, Yellow)</p> <ol style="list-style-type: none"> 4) Remove screws. (Ø4 x 10, 2 pcs.) 5) Slide the electric parts box toward the arrow mark and then remove the box from the bottom side of the main unit. <p>2. Attachment</p> <ol style="list-style-type: none"> 1) Attach the electric parts box and then perform wiring as original. <p>Notes 1</p> <hr/> <p>Check there is no missing or contact failure on the connectors.</p> <hr/> <p>Notes 2</p> <hr/> <p>Be sure to perform wiring as original.</p> <hr/> <ol style="list-style-type: none"> 2) Attach air filter, suction panel, and electric parts box as original. 	 
⑤	Control P.C. board	<p>1. Detachment</p> <ol style="list-style-type: none"> 1) Perform work of 1 of ④. (In the works of 1 of ④, removal of the control P.C. board is available even if you do not perform works after 4)). 2) Unlock the card edge spacers (5 positions) in the electric parts box to remove the control P.C. board. <p>2. Attachment</p> <ol style="list-style-type: none"> 1) Mount control P.C. board in the electric parts box as original. 2) Attach the electric parts box as original. 3) Be sure to perform wiring as original in the electric parts box. <p>NOTE</p> <hr/> <p>Check there is no missing or contact failure on the connectors.</p> <hr/> <ol style="list-style-type: none"> 4) Attach each air filter, suction panel or electric parts box cover as original. 	 <p>⚠ CAUTION When replacing PC. board, check no-mex paper is attached.</p> 

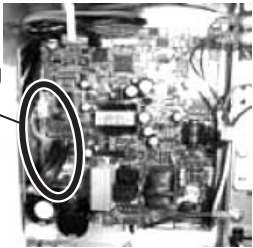
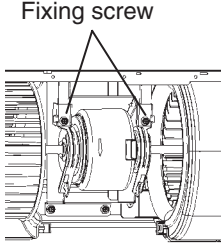
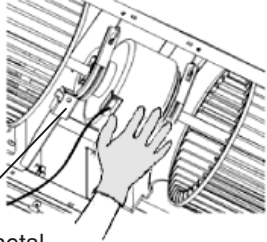
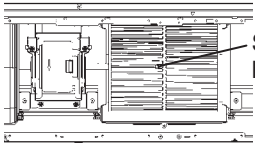
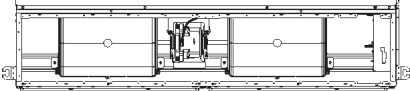
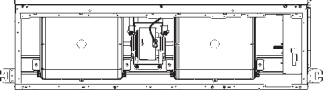
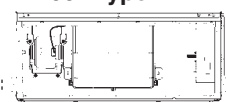
No.	Part name	Procedure	Remarks
⑥	PMV motor	<p>1) Open cover of the electric parts box and then remove relay connector of the PMV motor.</p> <p>2) As shown in the right figure, using a double spanner, open the check port at the side face and then remove the PMV motor.</p>	 <p>Relay connector of PMV motor</p>  <p>PMV motor</p> <p>Side check port</p>

No.	Part name	Procedure	Remarks
⑦	Fan motor, Fan, Fan case	<p>1. Detachment</p> <ol style="list-style-type: none"> 1) Perform works until opening of the electric parts box cover in works of 1 of ④. 2) Remove connectors for fan motor wiring from control P.C. board. CN333 : Motor power supply (5P: White) CN334 : Motor control (5P: White) 3) Open the fan case (under) and remove it while pressing claws of the fan case (under). (There are both sides of the case) 4) Remove the fixing screws (Ø5 x 10, 2 pcs.) of the fixing plate (2 pcs.) at the side of the fan motor. (The fan motor becomes temporal hanging status by fixing plate.) 5) While supporting the fan motor by hands, remove the fixing plate from the motor base to remove the fan motor. 6) Loosen the hexagonal screw hole of the fan and then pull out the fan from the shaft. (Hexagon wrench : 3mm) <p>2. Attachment</p> <ol style="list-style-type: none"> 1) Insert the fan in the shaft while adjusting to match the hexagonal screw hole to the groove of the shaft. 2) Perform screwing the fan motor with the fixing plate (Ø5 x 10, 2 pcs.) <p>NOTE</p> <hr/> <p>Match the fan motor with turning direction of the fan and fix so that the AP007 type and AP024 type fan motor wirings are at re rigerant piping side and AP036 type is at opposite side of refrigerant piping.</p> <hr/> <ol style="list-style-type: none"> 3) While positioning so that the fan is at the center of the fan case (upper), fix the fan with hexagonal screw. <p>NOTE</p> <hr/> <p>Be sure to use a torque wrench for fixing and tighten with 4.9N•m or more.</p> <hr/> <ol style="list-style-type: none"> 4) Attach the fan case (under) as original and check the fan turns smoothly without coming to contact with the fan case. 5) Connect the fan motor wirings as before, close and fix the electric parts box cover. Be sure to perform wirings as original in the electric parts box. 6) Attach air filter and suction panel as original position. 	 <p>Fan motor wiring CN333 CN334</p>  <p>Fixing screw</p>  <p>Fixing sheet metal</p>  <p>Screw with hexagonal hole</p> <p>AP036 Type</p>  <p>AP024 Type</p>  <p>AP007 Type</p>  <div style="border: 1px solid black; padding: 2px; display: inline-block;">Refrigerant piping side</div>  <p>⚠ CAUTION When replacing the fan motor, be sure to exchange the clamp filter with the fan motor lead wire.</p>

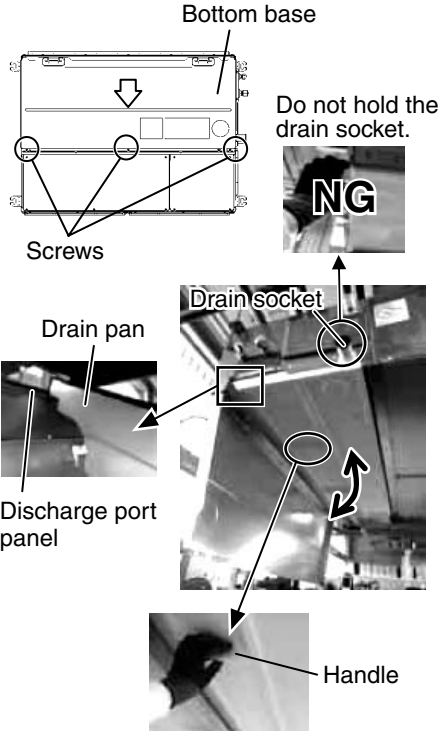
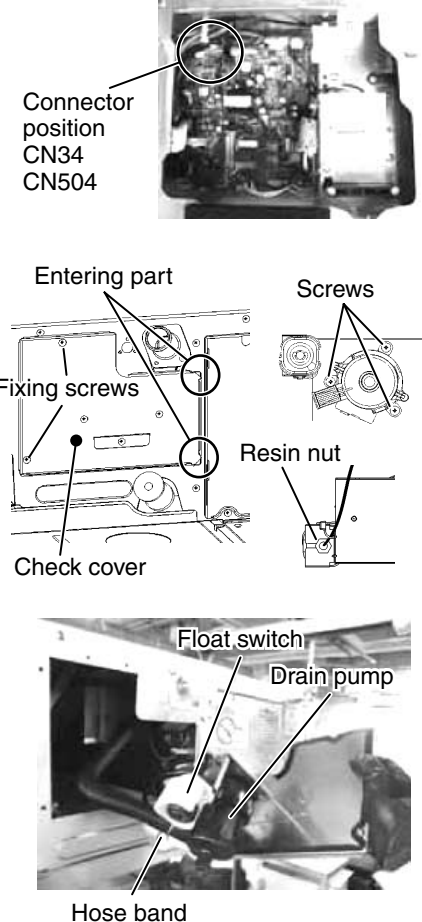
No.	Part name	Procedure	Remarks
⑧	Drain pan	<p>1. Detachment</p> <p>1) Remove the drain cap and then extract the drain water accumulated in the drain pan.</p> <p>NOTE</p> <p>When removing the drain cap, be sure to receive drain water using a bucket, etc.</p> <p>2) Loosen screws which fix the bottom base. (3 positions) (For AP036 models, remove 2 screws at the center.)</p> <p>3) As shown in the right figure, when sliding it toward arrow direction, the electric parts cover the bottom base opens using the hinge part as a shaft.</p> <p>4) Hold handle of the drain pan and then pull off slowly.</p> <p>CAUTION</p> <p>When removing the drain pan, do not hold the drain socket. (Water leakage may be caused.)</p> <p>2. Attachment</p> <p>1) First hook the thin side of the drain pan to the discharge panel and then push in the thick side.</p> <p>2) Close the bottom base and fix it with screws.</p>	
⑨	Drain pump Float switch	<p>1. Detachment</p> <p>1) Perform works until opening of the electric parts box cover in works of 1 of ④.</p> <p>2) Remove the connectors which connect to float switch of the drain pump from the control P.C. board. CN34 : Float switch (3P, Red) CN504 : Drain pump (2P, White)</p> <p>3) Remove the fixing screws (2 positions) of the check cover and then take out the check cover. (To the check cover, the drain pump and float switch are attached.)</p> <p>4) Pick up the hose band, shift from the pump connecting part, remove the drain hose and then remove the check cover.</p> <p>5) Remove screws which fix the drain pump assembly and then remove the drain pump assembly. (∅4 x 10, 3 pcs.)</p> <p>6) Remove the resin nut switch and then remove the float switch from the fixing plate.</p> <p>2. Attachment</p> <p>1) Using the removed screws, fix the drain pump assembly as original.</p> <p>2) Using the removed resin nut, fix the float switch as original.</p> <p>3) Connect the drain hose as original and then attach the hose band.</p> <p>4) Connect the drain pump and the float switch wiring as original and close the electric parts box cover for fixing. Be sure to perform wiring in the electric parts box as original.</p> <p>5) Enter the corners (2 positions) of the check cover in the entering part and then fix it using fixing screws (2 positions).</p>	

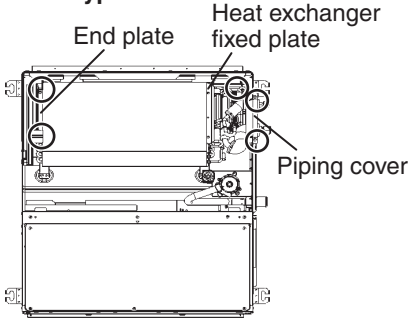
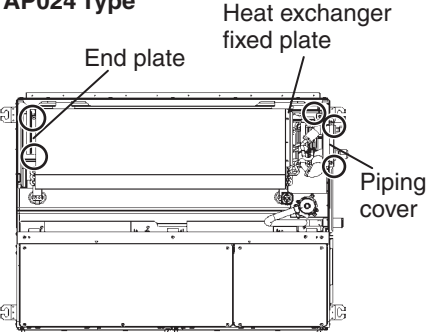
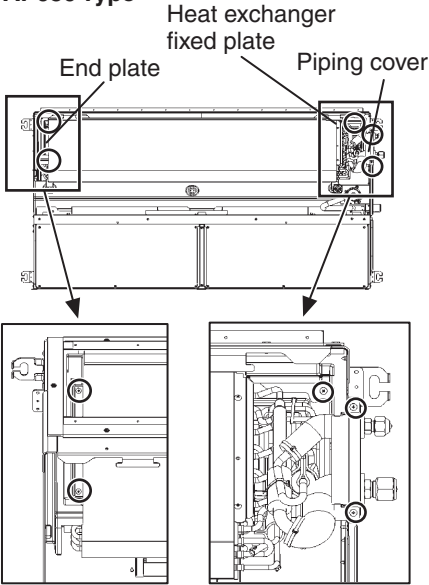
No.	Part name	Procedure	Remarks
⑩	Heat exchanger	<p>1. Detachment</p> <ol style="list-style-type: none"> 1) Recover the refrigerant gas and then remove the refrigerant pipe of the indoor unit. 2) Perform works of 1 of ⑧. 3) Pull out TC sensor and TCJ sensor wirings from the holder. 4) Remove the screws (Ø4 x 8, 2 pcs.) and then remove the piping cover. 5) Remove screws (Ø4 x 8, 1pc.) of the heat exchanger fixed plate. 6) While holding the heat exchanger, remove the fixed screws (Ø4 x 8, 2 pcs.) of the end plate and then take out the heat exchanger slowly. <p>2. Attachment</p> <ol style="list-style-type: none"> 1) Set the heat exchanger at the original position and fix it as before, using screws which removed the end plate, heat exchanger fixed plate and piping cover. 2) Enter TC sensor and TCJ sensor wirings in the holder and then perform wirings as original. 3) Attach the drain pan and the bottom base as original. 	<p>○ : Screw position</p> <p>AP007 Type</p>  <p>AP024 Type</p>  <p>AP036 Type</p> 

12. EXPLODED VIEWS AND PARTS LIST

12-1. Concealed duct standard type

MMD-AP0076BHP1-E(TR), MMD-AP0096BHP1-E(TR), MMD-AP0126BHP1-E(TR)

MMD-AP0156BHP1-E(TR), MMD-AP0186BHP1-E(TR)

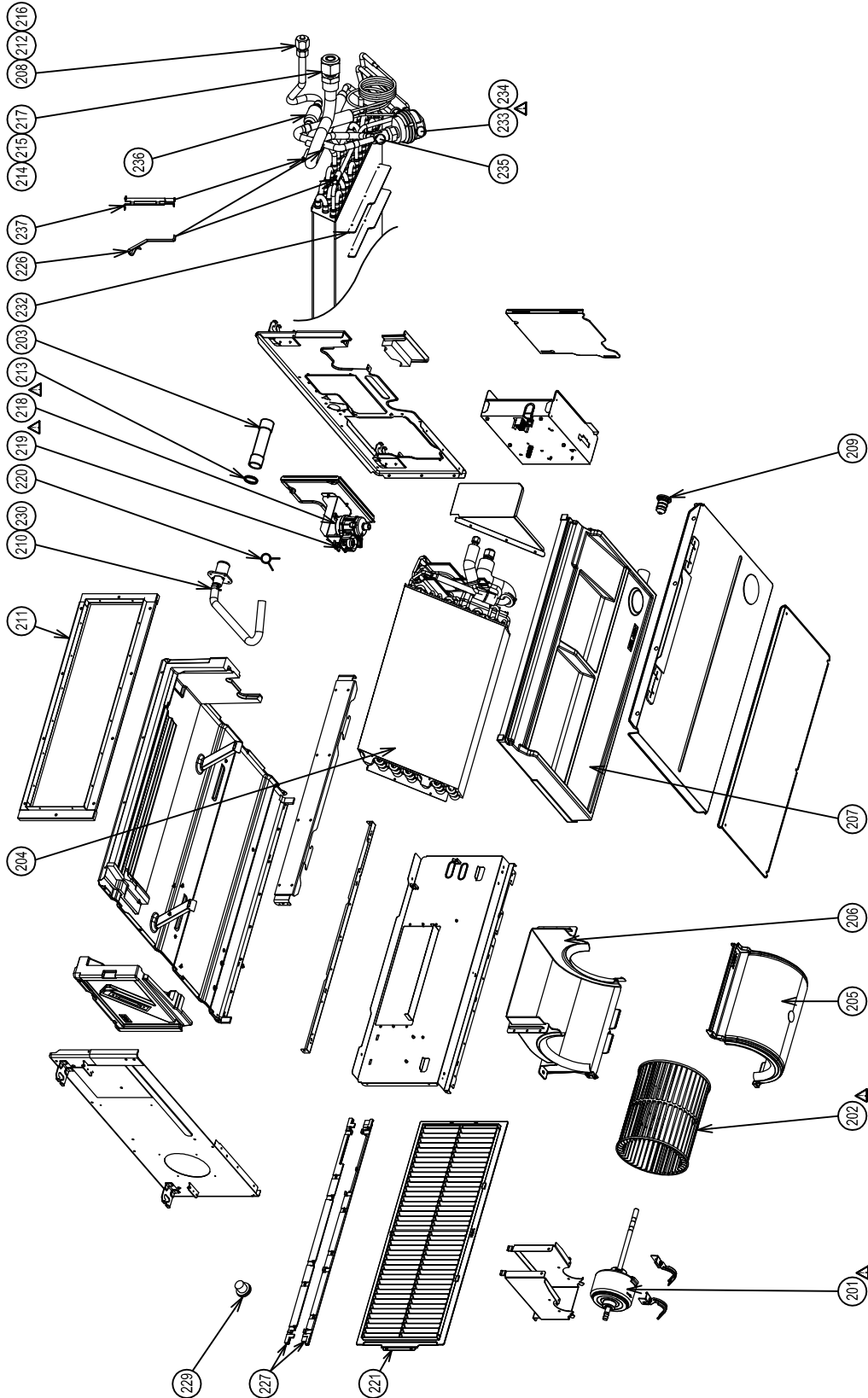

Location No.	Parts No.	Description	MMD-AP****BHP1-E (TR)				
			0076	0096	0126	0156	0186
201	43T21448	MOTOR, FAN	1	1	1	1	1
202	43T20340	FAN, MULTI BLADE	1	1	1	1	1
203	43T70315	HOSE, DRAIN	1	1	1	1	1
204	43T44522	REFRIGERATION CYCLE ASSY	1	1	1		
204	43T44523	REFRIGERATION CYCLE ASSY				1	1
205	43T22335	CASE, FAN, LOWER	1	1	1	1	1
206	43T22337	CASE, FAN, UPPER	1	1	1	1	1
207	43T72317	PAN ASSY, DRAIN	1	1	1	1	1
208	43T82319	SOCKET	1	1	1	1	1
209	43T79321	CAP, DRAIN	1	1	1	1	1
210	43T70319	HOSE,DRAIN	1	1	1	1	1
211	43T39356	FLANGE	1	1	1	1	1
212	43T47331	BONNET, 6.35 DIA	1	1	1	1	1
213	43T83311	BAND, HOSE	1	1	1	1	1
214	43T82318	SOCKET	1	1	1		
214	43T82320	SOCKET				1	1
215	43T97312	NUT, FLARE, 3/8 IN	1	1	1		
215	43T97317	NUT, FLARE, 1/2 IN				1	1
216	43T97311	NUT, FLARE, 1/4 IN	1	1	1	1	1
217	43T47332	BONNET, 9.52 DIA	1	1	1		
217	43T47333	BONNET, 12.70 DIA				1	1
218	43T77301	PUMP ASSY	1	1	1	1	1
219	43T51312	SWITCH, FLOAT	1	1	1	1	1
220	43T83307	BAND, HOSE	1	1	1	1	1
221	43T80340	AIR FILTER	1	1	1	1	1
226	43T19333	HOLDER, SENSOR	2	2	2	2	2
227	43T82329	RAIL, FILTER ASSY	1	1	1	1	1
229	43T82323	FILTER, STOPPER	1	1	1	1	1
232	43T39352	PLATE,WIND	2	2	2	2	2
233	43T46416	MOTOR, PMV	1	1	1	1	1
234	43T46417	SHEET, PMV	1	1	1	1	1
235	43T46413	VALVE, PMV	1	1	1		
235	43T46431	VALVE, PMV				1	1
236	43T47386	STRAINER	1	1	1	1	1
237	43T19321	FIX-P-SENSOR	1	1	1	1	1

MMD-AP0246BHP1-E(TR), MMD-AP0276BHP1-E(TR), MMD-AP0306BHP1-E(TR)

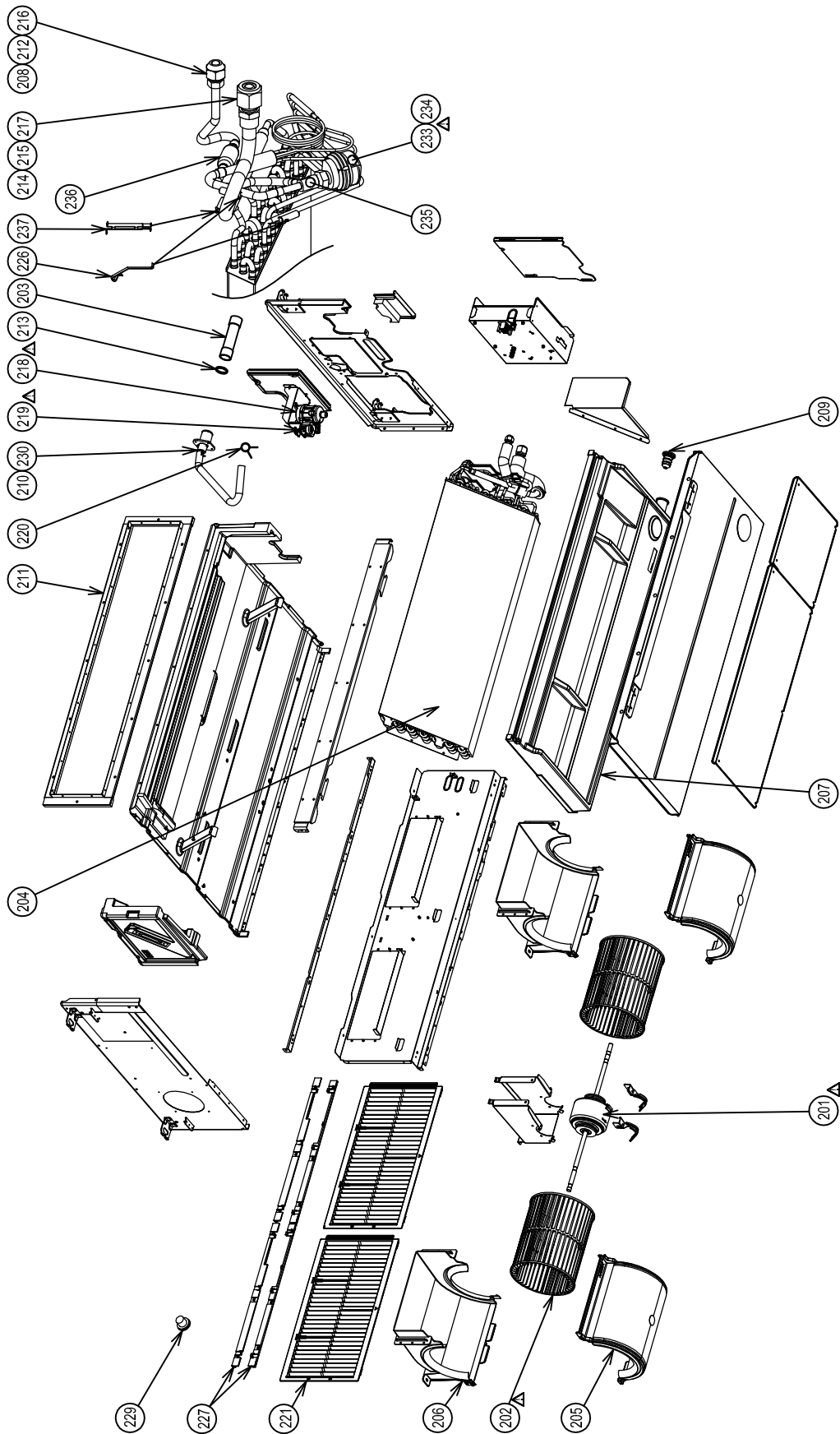

Location No.	Parts No.	Description	MMD-AP**** BHP1-E (TR)		
			0246	0276	0306
201	43T21447	MOTOR, FAN	1	1	1
202	43T20340	FAN, MULTI BLADE	2	2	2
203	43T70315	HOSE, DRAIN	1	1	1
204	43T44524	REFRIGERATION CYCLE ASSY	1	1	1
205	43T22335	CASE, FAN, LOWER	2	2	2
206	43T22337	CASE, FAN, UPPER	2	2	2
207	43T72318	PAN ASSY, DRAIN	1	1	1
208	43T82318	SOCKET	1	1	1
209	43T79321	CAP, DRAIN	1	1	1
210	43T70319	HOSE,DRAIN	1	1	1
211	43T39357	FLANGE	1	1	1
212	43T47332	BONNET, 9.52 DIA	1	1	1
213	43T83311	BAND, HOSE	1	1	1
214	43T82321	SOCKET	1	1	1
215	43T97314	NUT, FLARE, 5/8 IN	1	1	1
216	43T97312	NUT, FLARE, 3/8 IN	1	1	1
217	43T47334	BONNET; 15.88 DIA.	1	1	1
218	43T77301	PUMP ASSY	1	1	1
219	43T51312	SWITCH, FLOAT	1	1	1
220	43T83307	BAND, HOSE	1	1	1
221	43T80341	AIR FILTER	2	2	2
226	43T19333	HOLDER, SENSOR	2	2	2
227	43T82330	RAIL, FILTER ASSY	1	1	1
229	43T82323	FILTER, STOPPER	1	1	1
233	43T46416	MOTOR, PMV	1	1	1
234	43T46417	SHEET, PMV	1	1	1
235	43T46431	VALVE, PMV	1	1	1
236	43T47386	STRAINER	1	1	1
237	43T19321	FIX-P-SENSOR	1	1	1

MMD-AP0366BHP1-E(TR), MMD-AP0486BHP1-E(TR), MMD-AP0566BHP1-E(TR)

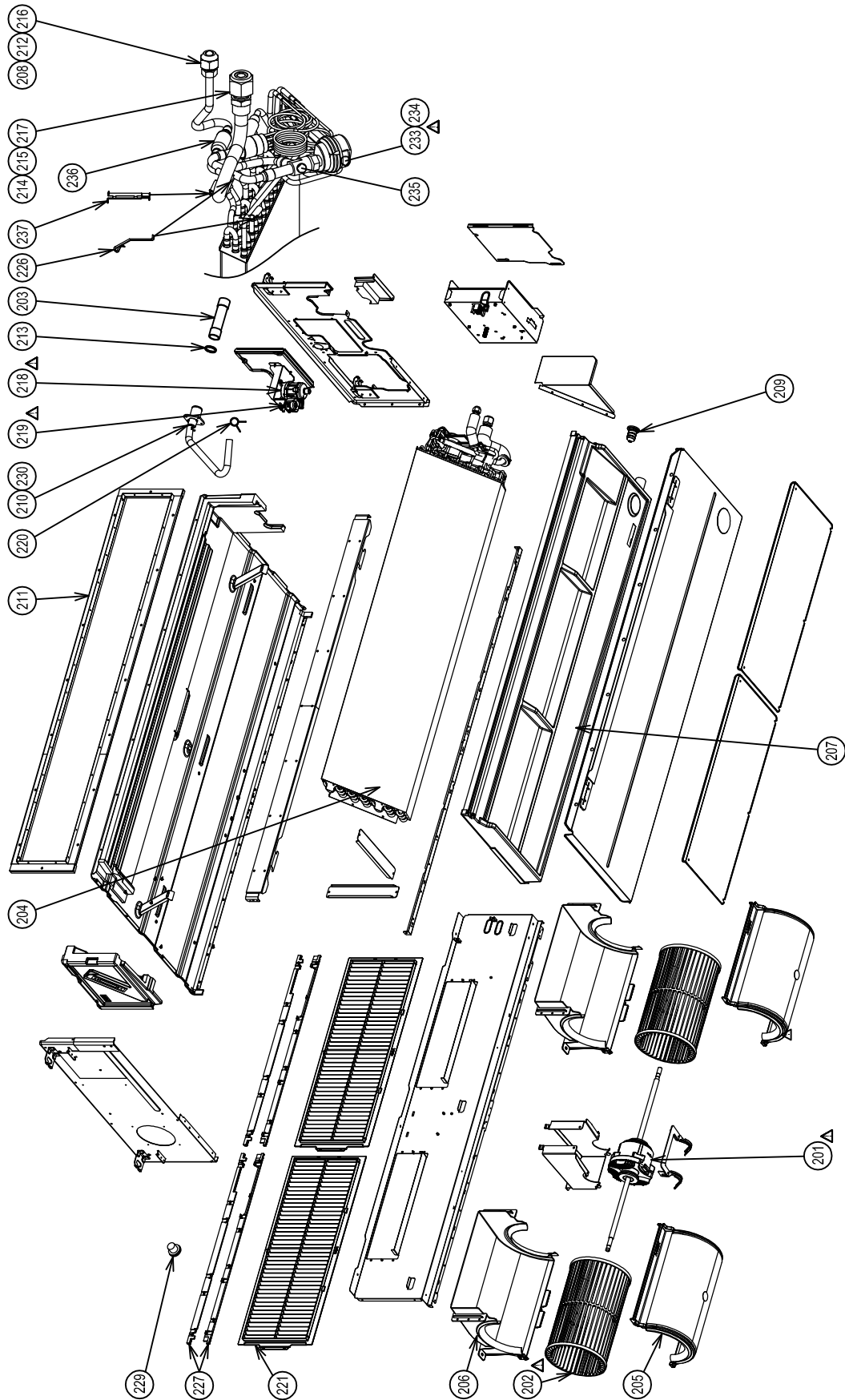

Location No.	Parts No.	Description	MMD-AP****BHP1-E (TR)		
			0366	0486	0566
201	43T21446	MOTOR, FAN	1	1	1
202	43T20339	FAN, MULTI BLADE	2	2	2
203	43T70315	HOSE, DRAIN	1	1	1
204	43T44525	REFRIGERATION CYCLE ASSY	1	1	1
205	43T22336	CASE, FAN, LOWER	2	2	2
206	43T22338	CASE, FAN, UPPER	2	2	2
207	43T72319	PAN ASSY, DRAIN	1	1	1
208	43T82318	SOCKET	1	1	1
209	43T79321	CAP, DRAIN	1	1	1
210	43T70318	HOSE,DRAIN	1	1	1
211	43T39358	FLANGE	1	1	1
212	43T47332	BONNET, 9.52 DIA	1	1	1
213	43T83311	BAND, HOSE	1	1	1
214	43T82321	SOCKET	1	1	1
215	43T97314	NUT, FLARE, 5/8 IN	1	1	1
216	43T97312	NUT, FLARE, 3/8 IN	1	1	1
217	43T47334	BONNET; 15.88 DIA.	1	1	1
218	43T77301	PUMP ASSY	1	1	1
219	43T51312	SWITCH, FLOAT	1	1	1
220	43T83307	BAND, HOSE	1	1	1
221	43T80340	AIR FILTER	2	2	2
226	43T19333	HOLDER, SENSOR	2	2	2
227	43T82331	RAIL, FILTER ASSY	1	1	1
229	43T82323	FILTER, STOPPER	1	1	1
230	43T83314	BAND, HOSE	1	1	1
233	43T46416	MOTOR, PMV	1	1	1
234	43T46417	SHEET, PMV	1	1	1
235	43T46415	VALVE, PMV	1	1	1
236	43T47386	STRAINER	1	1	1
237	43T19321	FIX-P-SENSOR	1	1	1

MMD-AP0076BHP1-E(TR), MMD-AP0096BHP1-E(TR), MMD-AP0126BHP1-E(TR)
 MMD-AP0156BHP1-E(TR), MMD-AP0186BHP1-E(TR), MMD-AP0246BHP1-E(TR)
 MMD-AP0276BHP1-E(TR), MMD-AP0306BHP1-E(TR), MMD-AP0366BHP1-E(TR)
 MMD-AP0486BHP1-E(TR), MMD-AP0566BHP1-E(TR)

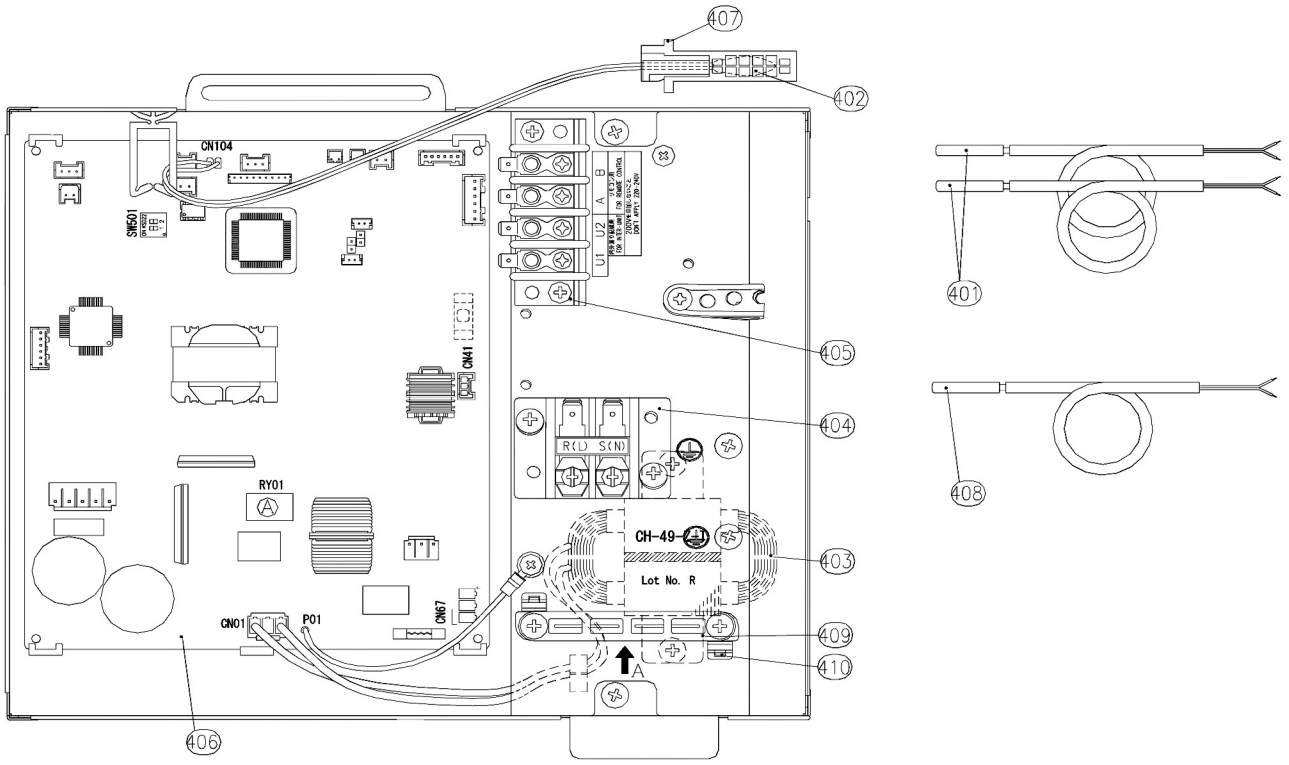

Location No.	Parts No.	Description	Q,ty / Set
401	43T50347	SENSOR ASSY, SERVICE	2
402	43T50476	SERVICE-SENSOR	1
403	43T58320	REACTOR	1
404	43T60435	SERV-TERMINAL	1
405	43T60362	TERMINAL	1
406	43T6V689	PC BOARD ASSY	1
407	43T50351	HOLDER-TA	1
408	43T50477	SERVICE-SENSOR	1
409	43T63348	CLAMP, DOWN	1
410	43T63349	CLAMP, UP	1

TOSHIBA CARRIER (THAILAND) CO.,LTD.

144/9 MOO 5, BANGKADI INDUSTRIAL PARK, TIVANON ROAD, TAMBOL BANGKADI,
AMPHUR MUANG, PATHUMTHANI 12000, THAILAND.